

can-am
SPYDER

SPYDER

2011 PARTS, ACCESSORIES & RIDING GEAR

can-am



2011

GEAR

RIDING GEAR	4
HOT WEATHER	6
COLD WEATHER	10
ALL WEATHER	14
WET WEATHER	17
TECHNICAL WEAR	19
MEN'S SPORTSWEAR	20
LADIES' SPORTSWEAR	23
SIZING CHART & TECHNICAL INFORMATION	25
HELMETS	26

PARTS & ACCESSORIES

RT ACCESSORIES	32
RT-622 TRAILER & ACCESSORIES	42
RS SPORT ACCESSORIES	45
RS TOURING ACCESSORIES	50
COVERS	55
WHEELS	56
OILS & MAINTENANCE	57
LICENSED PRODUCTS	59



Always ride responsibly and safely. Follow all instructional and safety materials. Always observe applicable local laws and regulations. Always wear a helmet, eye protection and appropriate protective clothing. And always remember that riding and alcohol/drugs don't mix. Because of its ongoing commitment to product quality and innovation, Bombardier Recreational Products Inc. (BRP) reserves the right, at any time, to discontinue or change specifications, prices, designs, features, models or equipment without incurring any obligations. Some models depicted herein may include optional equipment. Prices are based on Manufacturer's Suggested Retail Prices. Dealers may sell for a different price. Taxes are not included. In the U.S.A., products are distributed by BRP US Inc. In Canada, products are distributed by Bombardier Recreational Products Inc. Unless otherwise indicated in this catalog, ® and the BRP logo are trademarks of Bombardier Recreational Products Inc. or its affiliates. Bluetooth is a registered trademark of Bluetooth SIG. Clarino is a trademark of Kuraray Co., Ltd. Cordura® is a registered trademark of INVISTA for durable fabrics. Dri-Lexis is a registered trademark of Fyrite Corporation. Garmin is a registered trademark of Garmin Ltd. Monkey and Givi are registered trademarks of GIVI SRL. Hella is a registered trademark of Hella Inc. USA & Hella Inc. Hindle is a trademark of Hindle Exhaust System. Hipora is a registered trademark of Kolon Industries. Lexan is a registered trademark of SABIC Innovative Plastics Holding BV. iPod is a registered trademark of Apple Inc. Makrolon is a registered trademark of Bayer MaterialScience AG. Outlast® and Not too Hot. Not too Cold® are registered trademarks of Outlast Technologies Inc. Primaloft is a registered trademark of Albany International Corp. Quantum is a trademark of National Cycle Inc. RAM is a registered trademark of RAM Mounting Systems Inc. Scotchguard is a trademark of 3M Company. SuperFabric® is a registered trademark of HDM Inc. Sympatex is a registered trademark of SympaTex Technologies GmbH. Teflon, Teflon HT and Teflon HP are registered trademarks of E.I. DuPont de Nemours & Co. TFL Cool System® is a registered trademark of TFL Company. Velcro is a registered trademark of Velcro Industries. YKK is a registered trademark of YKK Corporation. All other trademarks are the property of their respective owners. © 2010 BRP. All rights reserved. Printed in Canada.

RIDING GEAR

**GEAR UP FOR
UNFORGETTABLE
RIDES**

Heading onto the open road calls for clothing that offers both comfort and a better riding experience.

BRP's specialized collection of Can-Am Spyder riding gear offers ergonomic design, fitted or classic cuts, and uses the latest technologies to adapt to your riding style and the elements.

We invented the Spyder roadster and it is the inspiration behind every item we design for our riding gear collection.

**Get the best out of every ride:
performance, durability and comfort.**





HOT WEATHER

Everything you want or need in warmer conditions without compromising style and protection. Breathable and comfortable, each piece is designed to make riding enjoyable on hot to mild days.



COLD WEATHER

For riders who won't let the cold keep them from the open road. Designed as a total fit with the Spyder roadster, it offers complete protection, ultimate comfort and absolute warmth no matter how cold it is.



ALL WEATHER

Want to pack smart when the weather packs a mixed bag? Get piece of mind with these multifunctional go anywhere in any weather suits. Water and wind proof, breathable with light removable insulation, it's the perfect gear to wear in any condition.







WET WEATHER

A rider essential. 100% waterproof and all-seam sealed, it's a must-pack on every ride because Mother Nature can be fickle.



















GEAR UP RIGHT

with Can-Am Spyder riding gear specially adapted to where you ride and the outside temperature, allowing you the ultimate and best performance possible.

WHAT TO WEAR		OUTDOOR WEATHER			
		HOT	MILD	COLD	WET
 HOT WEATHER	DC	—————	—————		
	SUMMER MESH	—————	—————		
	CALIBER	—————	—————		
 COLD WEATHER	CAN-AM LEATHER		—————	—————	
	VSS		—————	—————	
 ALL WEATHER	GTX	—————	—————	—————	—————
	KAVALIER	—————	—————	—————	—————
 WET WEATHER	RAIN				—————

SYMBOLS

See details p.25

	Water resistant		Removable insulated liner		Hipora [†]		SympaTex [®]
	100% Waterproof		Adjusted fit		DWR		Outlast [®]
	Windproof		Relaxed fit		Teflon [†]		Cordura [®]
	Jacket & Pant zipper connector		Pockets for removable protectors		RPM Max		TFL Cool System [®]



HOT
WEATHER



CALIBER SERIES



Ride from morning to evening with this water resistant Caliber suit that adapts to the temperature. Designed as a total fit with the Spyder roadster, its breathable RPM Max fabric – exclusive to BRP –, multiple vents and removable light insulation will keep you comfortable no matter what time of day.



MAGNESIUM (24)

BLUE (80)

BLACK (90)

MEN'S // Sizes: S, M, MT, L, LT, XL, XLT, 2XL, 3XL // 440533 - Magnesium (24), Blue (80), Black (90) // **\$259.99**



ICE (38)

BLUE (80)

BLACK (90)

LADIES' // Sizes: XS, S, M, L, XL, 2XL, 3XL // 440534 - Ice (38), Blue (80), Black (90) // **\$259.99**

JACKET

- All-seam sealed;
- Slightly shorter at front for comfort when seated on vehicle;
- Nape collar cushion edge;
- Shaped sleeves;
- Stretchable fabric inserts for extra comfort and stretch gusset at back armhole;
- Chest, sleeve and back ventilation;
- Multi-adjustable biceps, forearms and waist;
- Jacket-to-pants connector;
- Inside pouches for inserting removable back, shoulder and elbow protectors (sold separately);
- Napoleon pocket with easy MP3 access;
- Numerous exterior pockets;
- Teflon HT treated highly wear resistant fabric;
- Reflective details;
- May require rain suit in heavy rain conditions;
- Shell: Nylon.



NAPE COLLAR CUSHION EDGE



SHAPED SLEEVES



MAGNESIUM (24)

BLACK (90)



MAGNESIUM (24)

BLACK (90)

MEN'S // Sizes: 30, 32, 34, 34T, 36, 36T, 38, 38T, 40, 40T, 42, 44
441468 - Magnesium (24), Black (90) // **\$239.99**
Tall sizes: 46, 48 // 442393 - Black (90) // **\$259.99**

LADIES' // Sizes: 4, 6, 8, 10, 12, 14, 16
441467 - Magnesium (24), Black (90) // **\$239.99**
Tall sizes: 18, 20, 22 // 442394 - Black (90) // **\$259.99**

PANTS

- All-seam sealed;
- Thigh zippers for ventilation;
- Teflon HT treated highly wear resistant fabric;
- Stretch accordions above knees;
- Water resistant stretch fabric at seat and crotch for added comfort;
- Adjustable waist and hem;
- Full-length side zippers for slipping pants on while wearing boots;
- Jacket-to-pants connector;
- Ergonomic fit for added comfort when riding;
- Inside pouches for inserting removable knee protectors (sold separately);
- Reflective stripe at knee and back leg;
- May require rain suit in heavy rain conditions;
- Shell: Nylon.



STRETCH ACCORDIONS ABOVE KNEES

SUMMER MESH SERIES



The Summer Mesh suit will definitely make your riding during warm days a lot more enjoyable. Made with wear resistant mesh and featuring adjustable biceps, wrists, waist and pants hems, it provides comfort even on cool mornings and evenings, thanks to its light removable liner.

20% OFF
ON SUMMER MESH SERIES
WHILE QUANTITIES LAST*



BLACK (90)

MEN'S // Sizes: S, M, L, XL, 2XL, 3XL // 440471 - Black (90) // **\$239.99**
SPECIAL PRICE: \$191.99*



BLACK (90)

LADIES' // Sizes: XS, S, M, L, XL // 440476 - Black (90) // **\$239.99**
SPECIAL PRICE: \$191.99*

JACKET

- Stretchable fabric inserts;
- Shaped sleeves;
- Jacket-to-pants connector;
- Inside pouches for inserting removable back, shoulder and elbow protectors (sold separately);
- Easy access pockets, including one for MP3;
- Reflective details;
- Shell: Nylon, Polyester.



REFLECTIVE DETAILS



SHAPED SLEEVES



BLACK (90)

MEN'S // Sizes: 30, 32, 34, 36, 38, 40, 42, 44
441429 - Black (90) // **\$199.99**
SPECIAL PRICE: \$159.99*



BLACK (90)

LADIES' // Sizes: 4, 6, 8, 10, 12, 14, 16
441434 - Black (90) // **\$199.99**
SPECIAL PRICE: \$159.99*

PANTS

- Ergonomic fit with shaped pant legs;
- Jacket-to-pants connector;
- Stretchable fabric inserts for extra comfort;
- Inside pouches for inserting removable knee protectors (sold separately);
- Full-length side zippers for slipping pants on while wearing boots;
- Reflective details;
- Shell: Nylon, Polyester.



STRETCHABLE FABRIC INSERTS FOR EXTRA COMFORT

ADDITIONAL PROTECTION

REMOVABLE BACK PROTECTORS

Sizes: S, L, XL
447321 - Black (90)
\$24.99

LADIES' REMOVABLE ELBOW, KNEE OR SHOULDER PROTECTORS

Sold in pairs.
447322 - Black (90)
\$24.99

MEN'S REMOVABLE ELBOW, KNEE OR SHOULDER PROTECTORS

Sold in pairs.
447313 - Black (90)
\$24.99

DC SERIES



DWR

Make heads turn and ride with style and comfort with this ergonomic and water-repellent polyester-cotton abrasion-resistant denim suit that fits like streetwear. A riding combination that also delivers a very trendy look. Kevlar[†] inserts in key locations for added protection.



BLACK (90)

MEN'S // Sizes: S, M, L, XL, 2XL, 3XL // 440506 - Black (90) // **\$149.99**

JACKET

- Fabric treated with DWR;
- Mesh lining;
- Shaped sleeves;
- Aramid[†] stretch paneled at elbow;
- Adjustable at sides;
- Black oxidized metal zippered pockets and sleeve gusset;
- Reflective piping at front and back;
- Shell: Cotton, Polyester.



BLACK OXIDIZED METAL ZIPPERED POCKETS



BLACK (90)

LADIES' // Sizes: XS, S, M, L, XL, 2XL // 440507 - Black (90) // **\$149.99**

PANTS

- Fabric treated with DWR;
- Kevlar[†] inner reinforcement at knees, seat and hips;
- Triple needle stitching at crotch;
- Gusset at crotch and upper inseam to facilitate movement;
- Higher back waist and shaped legs;
- Double layer hem for reinforcement and durability;
- Shell: Cotton, Polyester.



HIGHER BACK WAIST



BLACK (90)

MEN'S // Sizes: 30, 32, 34, 36, 38, 40, 42, 44 // 441449 - Black (90) // **\$129.99**



BLACK (90)

LADIES' // Sizes: 4, 6, 8, 10, 12, 14, 16 // 441450 - Black (90) // **\$129.99**

MATCHING RIDING GLOVES



CHARCOAL GREY (07)

MEN'S RESPIRATOR GLOVES

Perforated leather gloves that deliver the best of both worlds: the protection of leather combined with excellent ventilation. Shaped fingers and molded knuckles for maximum fitted comfort and increased protection. Silicone print at palm for improved grip.

Shell: Leather

Sizes: S, M, L, XL, 2XL

446178 - Charcoal Grey (07), Black (90)

\$69.99

20% OFF
WHILE QUANTITIES LAST*
\$55.99



BLACK (90)

LADIES' SHORT VENTED GLOVES

Designed specifically for women. Perforated leather gloves that deliver best of both worlds: the protection of leather combined with excellent ventilation. Shaped fingers and molded knuckles for maximum fitted comfort and increased protection. Stretchable fabric inserts at knuckle joints.

Shell: Leather

Sizes: XS, S, M, L, XL

446180 - Black (90)

\$69.99



BLACK (90)

MEN'S MESH SUMMER GLOVES

Air mesh fabric for high ventilation and flexibility. Lightweight and comfortable. Hook-and-loop wrist closure. Pre-curved design for improved fit. Perforated Clarino[®] palm. Double Clarino[®] layer at palm and thumb for extra durability and comfort. Knuckle gussets for better mobility. Short cuff.

Shell: Polyester, Leather, Nylon

Sizes: S, M, L, XL, 2XL

446205 - Magnesium (24), Black (90)

\$34.99



MAGNESIUM (24)

BLACK (90)



*Only at participating Can-Am Spyder dealers.



COLD
WEATHER



CAN-AM LEATHER SERIES



Leather jacket and pants at their best! Their ergonomic fit and stretch fabric inserts will add to your comfort while riding. In addition to its numerous ventilation zippers and light removable insulation, the Can-Am Leather Series is equipped with inside pouches for inserting protectors (sold separately).

20% OFF
ON CAN-AM LEATHER SERIES
WHILE QUANTITIES LAST*



CHARCOAL GREY (07)

BLACK (90)

MEN'S // Sizes: S, M, L, XL, 2XL, 3XL // 440465 - Charcoal Grey (07), Black (90) // \$469.99

SPECIAL PRICE: \$375.99*

JACKET

- Nape collar cushion edge;
- Shaped sleeves;
- Stretchable fabric inserts for extra comfort;
- Chest, sleeve and back ventilation;
- Multi-adjustable biceps, forearms and waist;
- Jacket-to-pants connector;
- Napoleon pocket with easy MP3 access;
- Numerous exterior pockets;
- Reflective details;
- Shell: Genuine Cowhide Leather, Nylon.



WHITE (01)

BLACK (90)

LADIES' // Sizes: XS, S, M, L, XL // 440474 - White (01), Black (90) // \$469.99

SPECIAL PRICE: \$375.99*



SLEEVE VENTILATION



CHARCOAL GREY (07)

BLACK (90)

WHITE (01)

BLACK (90)

**MEN'S // Sizes: 30, 32, 34, 36, 38, 40, 42, 44
441412 - Charcoal Grey (07), Black (90) \$364.99**

SPECIAL PRICE: \$291.99*

**LADIES' // Sizes: 4, 6, 8, 10, 12, 14, 16
441432 - White (01), Black (90) \$364.99**

SPECIAL PRICE: \$291.99*

PANTS

- Stretch fabric above knees, at seat and crotch to facilitate movement;
- Adjustable waist and hem;
- Full-length side zippers for slipping pants on while wearing boots;
- Jacket-to-pants connector;
- Shell: Genuine Cowhide Leather, Nylon.



STRETCH FABRIC INSERTS



*Only at participating Can-Am Spyder dealers.

VSS LEATHER SERIES

The classic cut. The VSS Leather Series suits you just like a second skin and is made of soft full aniline leather. Very supple and comfortable, it offers you complete protection while keeping you warm.



BLACK (90)



BLACK (90)

MEN'S // Sizes: S, M, L, XL, 2XL, 3XL // 440537 - Black (90) // \$299.99

MEN'S // Sizes: 30, 32, 34, 36, 38, 40, 42, 44 // 441452 - Black (90) // \$249.99

JACKET

- Lightweight;
- Nape collar cushion edge;
- Nubuck strip;
- Embroidered logos;
- Elasticized accordions at side waist;
- Shaped sleeves;
- Inside pouches for inserting removable back, shoulder and elbow protectors (sold separately);
- Snap-tab collar and waist;
- Zippered gusset at sleeve;
- Reflective piping at front and back;
- Two zipper hand-warmer pockets;
- One interior zippered pocket;
- Shell: Leather.



REFLECTIVE PIPING AT FRONT AND BACK

PANTS

- Jeans cut;
- Gusset at crotch and upper inseam to facilitate movement;
- Higher back waist and shaped legs;
- Custom rubber button and trims for very trendy look and style;
- Belt loops;
- Shell: Leather.

MATCHING LEATHER RIDING GLOVES



MAGNESIUM (24)

MEN'S VSS LEATHER GLOVES

Full leather 3-season gloves perfect for Spring through Fall. Inverted seams provide increased feel to sensitive areas of hand for better grip and additional comfort. Reinforced palm. Shaped fingers for maximum fitted comfort. Articulated knuckle-joint system. Silicone print at palm for improved grip. Hook-and-loop wrist and cuff closure for secure fit. Protective foam on knuckles. Embroidered logos.

Shell: Leather

Sizes: S, M, L, XL, 2XL

446204 - Magnesium (24),
Black (90)

\$89.99



BLACK (90)



CHARCOAL GREY (07)

LADIES' VSS LEATHER GLOVES

3-season gloves perfect for Spring through Fall. Inverted seams provide increased feel to the sensitive areas of the hand for a better grip and additional comfort. Reinforced palm. Shaped fingers for maximum fitted comfort. Articulated knuckle-joint system facilitates handling. Silicone print at palm for improved grip.

Shell: Leather

Sizes: XS, S, M, L, XL

446179 - Charcoal Grey (07),
Black (90)

\$89.99

20% OFF
WHILE QUANTITIES LAST*
\$71.99



BLACK (90)

CLASSIC LONG LEATHER GLOVES

Spring-through-Fall gloves ideal for cooler days thanks to the insulation integrated into the glove design. Palm reinforced with kangaroo leather for superior grip and durability. Shaped fingers for maximum fitted comfort.

Insulation: Primaloft

Shell: Leather



BLACK (90)

MEN'S // Sizes: S, M, L, XL, 2XL

446186 - Black (90) // **\$119.99**

20% OFF
WHILE QUANTITIES LAST*
\$95.99



BLACK (90)

LADIES' // Sizes: XS, S, M, L, XL

446192 - Black (90) // **\$119.99**

20% OFF
WHILE QUANTITIES LAST*
\$95.99





ALL
WEATHER



GTX SERIES



The GTX is the perfect riding suit to extend your riding season, in any conditions. Designed with a Sympatex membrane, the suit is 100% water and wind proof and breathable. Scientifically tailored for high wear usage, it offers the best comfort even when the conditions aren't at their best.

JACKET

- 100% water and wind proof center quadruple flaps with two zippers and magnetic front closure;
- Light removable insulation;
- Cushioned chin collar, shaped sleeves, stretchable fabric inserts and multi-adjustable biceps, forearms and waist;
- Jacket-to-pants connector;
- Napoleon pocket, plus generous exterior pockets made with YKK® water resistant zippers;
- Inside pouches for inserting removable back, shoulder or elbow protectors (sold separately);
- Inner storm gaiter to avoid air/water infiltration;
- Reflective details for better visibility;
- Shell: Nylon.



SYMPATEX MEMBRANE

- 100% waterproof
- 100% windproof
- 100% breathable
- Resilient membrane
- 300% stretchable
- Most durable of all membranes, biodegradable

THE BEST PERFORMANCE ON THE MARKET.



STRETCH FABRIC INSERTS

MEN'S // Sizes: S, M, L, XL, 2XL, 3XL // 440511 - Black (90) // \$399.99
Tall sizes: 4XL, 5XL // 440540 - Black (90) // \$439.99

LADIES' // Sizes: XS, S, M, L, XL, 2XL // 440509 - Black (90) // \$399.99

PANTS

- Light removable insulation;
- Front fly, hip pockets and leg gusset with YKK water resistant zipper;
- Stretch fabric above knees, at seat and crotch for added comfort;
- Adjustable waist;
- Jacket-to-pants connector;
- Inside pouches for inserting removable knee protectors (sold separately);
- Reflective details for better visibility;
- Shell: Nylon.



STRETCH FABRIC INSERTS FOR ADDED COMFORT

MEN'S // Sizes: 30, 32, 34, 36, 38, 40, 42, 44
441455 - Black (90) // \$299.99
Tall sizes: 46, 48
441469 - Black (90) // \$329.99

LADIES' // Sizes: 4, 6, 8, 10, 12, 14, 16, 18
441453 - Black (90) // \$299.99

MATCHING RIDING GLOVES

SOFT SHELL TOURING GLOVES

Perfect glove for all-in-one coziness, waterproofness and breathability. Hipora, waterproof and breathable insert. Goat leather at palm. Moisture management lining keeps hands warm. Soft shell fabric is supple, light and quick-dry. Elastic at wrist palm and Velcro® adjustment at cuff. Pre-shaped fingers for maximum comfort.

Shell: Polyester, Leather, Nylon, Polyurethane, Spandex



MEN'S // Sizes: S, M, L, XL, 2XL
446193 - Black (90) // \$59.99
LADIES' // Sizes: S, M, L, XL
446194 - Black (90) // \$59.99



Note: If you intend to wear them over jeans, order one size up or try the pants over your jeans to validate the appropriate size.

KAVALIER SERIES



For riders seeking perfection and the most advanced technology. Top of the line Kavalier jacket combines Sympatex, Outlast® and TFL Cool System® to deliver 100% water and wind proofing, as well as body temperature regulation while riding. Its large watertight chest ventilation, light removable insulation make it convenient to wear anytime, anywhere.

THE ONLY PLACE WHERE YOU'LL FIND MORE TECHNOLOGY IS ON THE ROADSTER ITSELF!



MEN'S KAVALIER JACKET

- Extremely comfortable and breathable Sympatex membrane;
- Made of abrasion resistant CORDURA® fabric and SuperFabric® at elbow;
- Center front quadruple flaps with two zippers and magnetic front closure that render front opening 100% water and wind proof;
- Liner hood can be used under the helmet while riding in the rain to avoid water intrusion at neck;
- Jacket-to-pants connector;
- Napoleon pocket, plus generous exterior pockets made with YKK water resistant zippers (inner pockets are waterproof);
- Large pocket at bottom back;
- Inside pouches for inserting removable back, shoulder and elbow protectors (sold separately);
- Reflective stripes and details for greater visibility;
- TFL Cool System® on black color fabric only;
- Inner storm gaiter to avoid air/water infiltration;
- Shell: Nylon.

Sizes: S, M, L, XL, 2XL, 3XL
440536 - Grey (09), Black (90)
\$699.99

SYMPATEX MEMBRANE



- 100% waterproof
- 100% windproof
- 100% breathable
- Resilient membrane
- 300% stretchable
- Most durable of all membranes, biodegradable

THE BEST PERFORMANCE ON THE MARKET.



CHEST VENTILATIONS



LINER HOOD



BACK VENT / BACK POCKET



LIGHT REMOVABLE INSULATION / STORM GAITER



SHAPED SLEEVES / STRETCHABLE INSERTS

MATCHING RIDING GLOVES



BLACK (90)

MEN'S SYMPATEX GLOVES

All weather 3-season gloves. Sympatex insert membrane for wind, water proofness, and breathability. Nylon textile and leather outer shell construction. Goat leather at palm with synthetic suede reinforcements. Moisture management lining. Hook-and-loop closure at wrist and cuff. Watertight zipper at cuff for quick and easy slip-on. Articulated knuckle-joint system. Padded foam at knuckles. Outlast® technology for temperature regulation. Reflective piping and "Y" logo. Pre-shaped fingers for maximum comfort.

Shell: Polyester, Leather, Nylon

Sizes: S, M, L, XL, 2XL
446207 - Black (90)

\$104.99





WET
WEATHER



RAIN SERIES

A must-pack on every ride! The Rain Series gear is 100% waterproof and all-seam sealed. It's also made for easy traveling since it conveniently packs in its pouch. Store it in your vehicle to avoid unpleasant situations.



BLACK (90)

ONE PIECE RAIN SUIT

- Features an innovative liner hood made for use under the helmet while riding to avoid water infiltration;
- Wind and water proof Nylon PVC fabric with Teflon HP¹;
- Water deflecting double layer storm flaps with gutter over main zipper;
- Elasticized Velcro adjustable wrists;
- Quick-release adjustable buckle at waist;
- Easy access cargo pocket on left thigh;
- Cozy collar lined with brushed polyester;
- Napoleon pocket;
- Large reflective bands for higher visibility;
- Shell: Waterproof Nylon.

Sizes: XS, S, M, L, XL, 2XL, 3XL
440535 - Black (90)

\$139.99

CAN BE
PACKED IN
ITS POCKET



BLACK (90)

RAIN JACKET

- Unique and innovatively made with 2 retractable hoods, i.e. a conventional hood and a liner hood for use under the helmet while riding to avoid water infiltration;
- Light, waterproof and packable Ripstop Nylon fabric with Teflon;
- Back ventilation for moisture evacuation;
- Water deflecting double layer storm flaps with gutter over main zipper;
- Elasticized Velcro adjustable wrists;
- Adjustable drawstring at collar, waist and hem;
- Shaped sleeves;
- Two Velcro waist pockets with flap;
- Cozy collar lined with brushed polyester;
- Napoleon pocket;
- Reflective details at front, back and sleeves;
- Shell: Waterproof Ripstop Nylon.

Sizes: XS, S, M, L, XL, 2XL, 3XL
440510 - Black (90)

WAS \$149.99

NEW PRICE \$119.99



BLACK (90)

RAIN PANTS

- Waterproof, Teflon treated, Ripstop Nylon fabric;
- Lightweight;
- Velcro hemmed large side leg gusset for slipping pants over boots;
- Elasticized waist with drawstring;
- Two Velcro hip pockets with double flap to prevent water intrusion;
- Women: order one size down;
- Shell: Waterproof Ripstop Nylon.

Sizes: XS, S, M, L, XL, 2XL, 3XL
441454 - Black (90)

WAS \$99.99

NEW PRICE \$79.99



FOLDS INTO
JACKET BACK
POCKET FOR
EASY TRAVELING

TECHNICAL WEAR



CAN-AM TECHNICAL SERIES

Soft shell combines light insulation, breathability and waterproofing. Ideal for wearing as an insulating first layer on cold days.



BLACK (90)

MEN'S // Sizes: S, M, L, XL, 2XL, 3XL // 440469 - Black (90) // \$129.99



BLACK (90)

LADIES' // Sizes: XS, S, M, L, XL // 440477 - Black (90) // \$129.99

JACKET

4-way stretch fabric. Ergonomic fit for added comfort when riding. Shaped sleeves. Reflective details.

Content: Polyester

PANTS

4-way stretch fabric. Shaped knees. Ergonomic fit for added comfort when riding. Trendy ready-wear fit. Reflective details.

Content: Polyester



BLACK (90)

MEN'S // Sizes: 30, 32, 34, 36, 38, 40, 42, 44 // 441427 - Black (90) // \$119.99



BLACK (90)

LADIES' // Sizes: 4, 6, 8, 10, 12, 14 // 441435 - Black (90) // \$119.99



NECK WARMER

Keeps you warm while providing breathable and windproof performance. Can be adjusted to fit every morphology with toggle and drawstring at back.

Content: Polyester, Spandex
One size
447410 - Black (90)
\$29.99



MICRO-FLEECE BALACLAVA

Stretchable, antibacterial warm fleece fabric with brushed inner surface. Flatlocked seams prevent skin chafing.

Content: Polyester, Spandex
One size
445952 - Black (90)
\$21.99



BASIC BALACLAVA

No-nonsense balaclava designed for warmth, dryness and comfort. Flatlocked seams prevent skin chafing.

Content: Nylon, Spandex
One size
447449 - Black (90)
\$9.99

MEN'S

SPORTSWEAR





WHITE (01) NAVY (89)

Y CLASSIC POLO

Rib collar. Hidden placket with contrasting tape. "Y" logo embroidery badge at left chest. Can-Am Spyder embroidery below back neck seam.

Content: 65% Polyester, 35% Cotton

Sizes: S, M, L, XL, 2XL, 3XL

453558 - White (01), Navy (89)

\$34.99



WHITE (01) BLACK (90)

CAN-AM T-SHIRT

Print at front.

Content: 100% Cotton

Sizes: S, M, L, XL, 2XL, 3XL

453432 - White (01), Black (90)

\$19.99



WHITE (01) CHARCOAL GREY (07) BLACK (90)

CALIBER POLO

Antibacterial fabric. Body mapping polo technology. Press-down button placket at front.

Content: 100% Polyester

Sizes: S, M, L, XL, 2XL

453347 - White (01), Charcoal Grey (07), Black (90)

\$49.99



BLACK (90)

MICRO POLYESTER TOP

4-way stretch antibacterial fabric. Ideal for wearing as a first layer to keep you warm and dry. Shaped sleeves for extra comfort when riding. Welded pocket and details. Reflective details.

Content: 92% Polyester, 8% Spandex

Sizes: S, M, L, XL, 2XL

453346 - Black (90)

\$69.99



MAGNESIUM (24)



BLACK (90)



RED (30)



SAND (03)

CAN-AM Y CAP

Adjustable cap. "Y" logo metal pin at front. Embroidery at back strap.

Content: 100% Cotton
One size

447397 - Sand (03), Orange (12), Magnesium (24)

\$19.99



ORANGE (12)



WHITE (01)

CALIBER CAP

Stretchable cap. Rubber injected logo front and back.

Content: 98% Cotton, 2% Spandex
Sizes: S/M, L/XL, 2XL

447318 - White (01), Charcoal Grey (07), Black (90)

\$17.99

50% OFF
WHILE QUANTITIES LAST*
\$9.00



CHARCOAL GREY (07)



CHARCOAL GREY (07)

STRIPES CAP

Adjustable comfort back strap. Embroidered logos.

Content: 100% Cotton
One size

447317 - Charcoal Grey (07), Red (30), Black (90)

\$17.99



BLACK (90)



CHARCOAL GREY (07)

WHITE (01)

BLACK (90)

CALIBER TECHNICAL T-SHIRT

Antibacterial fabric. Back and underarm ventilation. Printed logos.

Content: 100% Polyester

Sizes: S, M, L, XL, 2XL, 3XL // 453349 - White (01), Charcoal Grey (07), Black (90)

\$34.99



WHITE (01)

BLACK (90)

CAN-AM SHORT SLEEVE SHIRT

Back ventilation. Two front pockets. Embroidered details and logo engraved on metal plate attached to pocket flap.

Content: 100% Cotton

Sizes: S, M, L, XL, 2XL // 453348 - White (01), Black (90)

\$49.99



CHARCOAL GREY (07)

WHITE (01)

BLACK (90)

VSS TECHNICAL T-SHIRT

Antibacterial fabric. Textured fabric inserts. Printed logos front and back.

Content: 100% Polyester

Sizes: M, L, XL, 2XL, 3XL // 453350 - White (01), Charcoal Grey (07), Black (90)

\$34.99



RED (30)

CHARCOAL GREY (07)

CAN-AM SWEATER

Stylish sporty long-sleeve sweater. Embroidered details and logo engraved on metal plate attached to front.

Content: 77% Cotton, 20% Nylon, 3% Elasthane

Sizes: S, M, L, XL, 2XL, 3XL // 453351 - Charcoal Grey (07), Red (30)

\$74.99

LADIES' SPORTSWEAR





WHITE (01)

NAVY (89)

CALIBER CAP

Stretchable thanks to back elastic. Can-Am Spyder label on right side and "Y" logo decorative snap on left side. Contrasting insert on each side of brim.

Content: 100% Cotton

Sizes: S/M, L/XL

447398 - White (01), Navy (89)

\$22.99



WHITE (01)

CHARCOAL GREY (07)

CAN-AM SWEATER

Stylish sporty long-sleeve sweater. Subtle rib knit back detail. Logo engraved on metal plate attached to front.

Content: 77% Cotton, 20% Nylon, 3% Elasthane

Sizes: XS, S, M, L, XL

453356 - White (01), Charcoal Grey (07)

\$74.99



CHARCOAL GREY (07)

WHITE (01)

MICRO POLYESTER TOP

Stylish yet sporty, comfortable, stretchable, soft against skin. Ultra feminine cut. Antibacterial fabric. Mesh inserts. Printed logos front and back.

Content: 92% Polyester, 8% Elasthane

Sizes: XS, S, M, L, XL

453352 - White (01), Charcoal Grey (07)

\$69.99



CHARCOAL GREY (07) RASPBERRY (39)

KNIT TEE

Short-sleeve knit tee designed for comfort and style. V neckline. Shoulder and front pleats. Logo engraved on metal plate attached to front.

Content: 77% Cotton, 20% Nylon, 3% Elasthane

Sizes: XS, S, M, L, XL

453355 - Charcoal Grey (07), Raspberry (39)

\$44.99



RED (30)

WHITE (01)

CALIBER POLO

Stylish yet sporty, comfortable, stretchable, soft against skin. Fitted cut follows curves for shapely look. Logo engraved on metal plate attached to front.

Content: 95% Cotton, 5% Spandex

Sizes: XS, S, M, L, XL

453354 - White (01), Red (30)

\$49.99



WHITE (01)

RED (30)

STRIPE TANK

Sporty feminine tank top. Antibacterial fabric. Sewn-in bra. Printed logos front and back.

Content: 92% Polyester, 8% Elasthane

Sizes: XS, S, M, L, XL

453353 - White (01), Red (30)

\$34.99

SIZING CHART

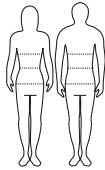

Chest/Bust //
Measure under your arms, around the fullest part of your chest.

Waist //
Measure around your natural waistline, keeping one finger between the tape and body.

Gloves //
Measure palm width.

Inseam //
Without shoes, from crotch to the floor.

Arm length //
Hand on hip, from center back neck bone, along shoulder point around elbow to bottom of wrist bone.

Helmet //
Measure around your head at the temple above the eyebrow.

For tall sizes, look for the "T" beside sizes. Example: "MT" stands for Medium Tall.

MEN	XS	S	M	MT	L	LT	XL	XLT	2XL	3XL	4XL	5XL
Chest	33-35	36-38	39-41	39-41	42-44	42-44	46-48	46-48	50-52	54-56	58-60	61-63
Waist	28-30	30-32	33-35	33-35	36-39	36-39	41-43	41-43	45-48	50-52	54-56	64-68
Hips (seat)	32-34	35-37	38-40	38-40	41-43	41-43	45-47	45-47	49-51	53-55	56-57	66-67
Arm length	31	33	33	34 1/2	34	35 1/2	34	35 1/2	35	35	36	36
Inseam	31	32	32	34	32	34	33	35	33	33	33	33

MEN'S PANTS	30	32	34	34T	36	36T	38	38T	40	40T	42	44	46	48
Waist	30-32	32-34	34-36	34-36	36-38	36-38	38-40	38-40	40-42	40-42	42-44	44-46	46-48	48-50
Hips (seat)	35-37	37-39	39-41	39-41	41-43	41-43	43-45	43-45	45-47	45-47	47-49	49-51	51-53	53-55
Inseam	32	32	32	34	32	34	32	34	33	35	33	33	33	33

LADIES	XS	S	M	L	XL	2XL	3XL
Chest	32 1/2-33 1/2	34 1/2-35 1/2	36 1/2-38	39 1/2-41	43-45 1/2	47-49 1/2	51-53
Waist	24 1/2-25 1/2	26 1/2-27 1/2	28 1/2-30	31 1/2-33	35-37	39-41	43-45
Hip (seat)	34 1/2-35 1/2	36 1/2-37 1/2	38 1/2-40	41 1/2-43	45-47	49-51	53-55
Arm length	29	30	31	32	32	32	32
Inseam	29	29	30	30	30	30	30

LADIES' PANTS	4	6	8	10	12	14	16	18	20	22
Waist	24-26	26-28	28-30	30-32	32-34	34-36	36-38	38-40	40-42	42-44
Hips (seat)	34-36	36-38	38-40	40-42	42-44	44-46	46-48	48-50	50-52	52-54
Inseam	29	29	30	30	30	30	30	30	30	30

MEN'S GLOVES	S	M	L	XL	2XL
Inches	3	3 3/8	3 3/4	4 1/8	4 1/2
cm	7.5	8.5	9.5	10.5	11.5

LADIES' GLOVES	XS	S	M	L	XL
Inches	2 1/4	2 5/8	3	3 1/4	3 1/2
cm	5.7	6.8	7.5	8.3	9

HELMETS	XS	S	S/M	M	M/L	L	XL	2XL	3XL
Helmet size	6 1/2-6 3/4	6 7/8-7	7 1/8	7 1/8-7 1/4	7 1/4	7 3/8-7 1/2	7 5/8-7 3/4	7 7/8-8	8 1/8-8 1/4
Head (cm)	53-54	55-56	57	57-58	58	59-60	61-62	63-64	65-66
Head (inches)	20 7/8-21 1/4	21 5/8-22	22 3/8	22 3/8-22 3/4	22 3/4	23 1/8-23 5/8	24-24 3/8	24 3/4-25 1/8	25 3/8-25 7/8

TECHNICAL INFORMATION

HIPORA // Windproof, breathable and waterproof membrane that features unique polyurethane coating technology and delivers excellent moisture management.

DWR // DWR stands for Durable Water Repellency. This treatment helps prevent the outer fabric surface from absorbing water, keeping the outerwear both light and comfortable.

TEFLON // Teflon provides an invisible barrier around fabric fibers to repel water and stains. In addition to retaining its water shedding properties longer than standard Teflon, Teflon HT and HP are also even more resistant to soiling and staining without altering the fabric's color, appearance, structure, texture and breathability. Teflon HT, good up to 20 washes and Teflon HP up to 30 washes compared to manufactured coatings washable only 1 to 5 times.

RPM MAX // Respirative Performance Matrix coating exclusive to BRP riding gear, for perfect climate control. Shell waterproofed, windproofed and breathable to BRP riding gear specifications for demanding riders. Sealed seams and logos. Extra direct venting for more efficient moisture management during intense riding or warm weather.

SYMPATEX // Best membrane on market. Most durable, waterproof, breathable, biodegradable. No loss of technical properties as garment ages. Seams are 100% waterproof sealed with original Sympatex tape. Built with strict set of standards voluntarily applied by manufacturer over and above industry requirements.

OUTLAST // Outlast® technology is the original temperature-regulating technology. Outlast® technology balances your temperature through the use of patented Thermocules™ that absorb and store excess heat, releasing it when you need it most. Products with Outlast® technology respond to your constantly changing body temperature to help keep you comfortable. Not too Hot, Not too Cold®

CORDURA // Fabric designed for living and built to last, providing exceptional resistance to tears, scuffs and abrasions.

TFL COOL SYSTEM // Sun energy reflective technology used on black textile to improve thermal balance for ultimate wearing comfort.

For best results, have someone else take measurements. Measure body in underwear. Tape must be snug but not tight. If measurements fall between two sizes, order the larger size.

What code represents your size?

- 1 / Find your size.
- 2 / The corresponding code is **THE CODE** you use to complete the part number on your order.
Example: 440 227__90
Size: **M** = code 06
Therefore 440 227 **06** 90

Size	Code	Size	Code	Size	Code
One Size	00	S/M	72	34	39
XS	02	M/L	91	34T	94
S	04	4	23	36	40
M	06	6	25	36T	96
MT	07	8	28	38	41
L	09	10	30	38T	97
LT	10	12	32	40	42
L/XL	73	14	34	40T	98
XL	12	16	35	42	43
XLT	13	18	78	44	44
2XL	14	20	92	46	45
3XL	16	22	93	48	46
4XL	18	30	37		
5XL	88	32	38		

SYMBOLS



Hot weather



All weather



Cold weather



Wet weather



Jacket & Pant zipper connector
Prevents lower back air infiltration, and jacket/pants from riding up/down.



Water resistant
To keep dry in light rain conditions or on short rides.



100% Waterproof
To keep dry in all conditions.



Windproof
To protect from air infiltration.



Removable insulated liner
To adapt to the current temperature. Wear when cold, remove when warm.



Adjusted fit
Fits closer to the body.



Relaxed fit
Looser fit for relaxed riding position.



Pockets for removable protectors
Pouches to insert removable protectors.

HELMETS



CAN-AM ST-1 HYBRID HELMET

Innovative lightweight motorcycle-helmet-inspired concept with multiple functionalities when fitted with optional one-of-a-kind jaws and unique integrated communication capabilities.

BUILD YOUR OWN HELMET: 1 HELMET - 4 COLORS - 3 LAYOUTS

CAN-AM ST-1 HYBRID HELMET

Multiple functionalities when fitted with optimal one of a kind jaws. Ventilation features include two ventilation tab kits (one open and one closed) with anti-fog spray kit, triple configuration flexibility (jet, vented and full face), continuous top ventilation and exhaust. Double D ring closure. Anti-scratch visor, retractable sun visor. Moisture-wicking and breathable removable liner and cheek pads. Optional longer visor, vented and full face jaws sold separately. D.O.T. certified.

Shell: Polycarbonate Composite

Sizes: XS, S, S/M, M/L, L, XL

447427 - White (01), Silver (08), Blue (80), Black (90)

\$299.99

CAN-AM ST-1 HYBRID HELMET WITH BUILT-IN COMMUNICATION SYSTEM

(Not illustrated)

Integrated communication capabilities. Works in conjunction with CB & Communication system (219400145) available as an option on Can-Am Spyder RT.

Shell: Polycarbonate Composite

Sizes: XS, S, S/M, M/L, L, XL

447437 - White (01), Silver (08), Blue (80), Black (90)

\$479.99



WHITE(01)



SILVER (08)



BLUE (80)



BLACK (90)

HOW TO BUILD YOUR OWN SPYDER RT COMMUNICATION SYSTEM

1. CHOOSE A HELMET WITH A SPYDER COMMUNICATION HEADSET



OR



Can-Am ST-1 Hybrid Helmet
447427 - White (01), Silver (08), Blue (80), Black (90)

Communication Headset (wired)
447438 - Driver/Passenger

Can-Am ST-1 Hybrid Helmet with built-in Communication Headset
447437 - White (01), Silver (08), Blue (80), Black (90)

2. GET THE SPYDER CB & COMMUNICATION SYSTEM, THE ENTERTAINMENT HARNESS, AND IF NOT STANDARD ON YOUR RT UNIT, THE AM/FM INTEGRATED AUDIO SYSTEM



ENTERTAINMENT HARNESS



COMES STANDARD ON RT-AUDIO & CONVENIENCE AND RT-S MODELS.

CB & Communication System // 219400145

(Not illustrated) // 219400201

AM/FM Integrated Audio System // 219400146

3. YOU MAY ALSO WANT AS AN OPTION...



Push-to-talk for Passenger
4474760090



GPS Navigation System
219400149



XM Satellite Radio Kit
219400148



Passenger Speakers and Audio Control
219400150

*219400146 AND 219400201 ARE REQUIRED FOR INSTALLATION.

NOTE: STANDARD ON RT-S MODELS

CAN-AM ST-1 HYBRID HELMET ACCESSORIES



WHITE (01)

SILVER (08)

BLUE (80)

BLACK (90)



CAN-AM ST-1 HYBRID VENTED JAW

Transforms the ST-1 Hybrid Helmet into a jet ventilated full-face helmet for enhanced protection with ventilation comfort.

One size
447429 - White (01), Silver (08), Blue (80), Black (90)

\$69.99



WHITE (01)

SILVER (08)

BLUE (80)

BLACK (90)



CAN-AM ST-1 HYBRID FULL FACE JAW

Transforms the ST-1 Hybrid Helmet into a standard full-face helmet for extra wind protection.

One size
447428 - White (01), Silver (08), Blue (80), Black (90)

\$69.99



COMMUNICATION HEADSET (WIRED)

For driver and passenger. Includes headset and microphone. Works in conjunction with the CB & Communication system (219400145) available as an option on Can-Am Spyder RT.

One size
447438 - Black (90)

\$189.99



PUSH-TO-TALK REMOTE FOR PASSENGER

Push-To-Talk remote control for passenger to be used with the Communication Headset (4474380090). Enables the vehicle to vehicle communication capability for the passenger via the CB & Communication System in push-to-talk mode. Works in conjunction with the CB & Communication System (219400145) available as an option on Can-Am Spyder RT.

One size
447476 - Black (90)

\$59.99



CAN-AM ST-1 HARDWARE KIT FOR VISOR AND JAW

Includes screws (2), left cover plate (1), right cover plate (1), ratchets (2), left jaw cover (1), right jaw cover (1), plastic key (1).

One size
447433 - Black (90)

\$24.99



CAN-AM ST-1 HARDWARE KIT FOR TOP VENT

Includes left open top vent (1), right open top vent (1), left closed top vent (1), right closed top vent (1), plastic key (1).

One size
447432 - Black (90)

\$24.99



LONG

SHORT

CAN-AM ST-1 HYBRID SINGLE PANE VISOR

Optically-correct polycarbonate shield with hardcoated anti-scratch technology.

One size
LONG - 447430 - Clear (00)
SHORT - 447431 - Clear (00)

\$49.99

CAN-AM GSX-4 FULL FACE HELMET & ACCESSORIES



30% OFF
ON CAN-AM GSX-4
FULL FACE HELMET



SILVER (08)



BLACK (90)



SMOKE 80% (20)



SMOKE 60% (21)



MIRROR SILVER (22)

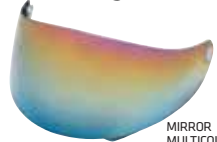

MIRROR MULTICOLOR (23)



CAN-AM GSX-4 FULL FACE HELMET

Integrated Pinlock[®] visor. 8 vents, back extraction, Venturi effect. V.P.F.S. Visor Perfect Fit System (perfect airtightness/visor fit). 2 shell sizes. Double D ring closure. Anti-scratch visor. Dri-Lex[®] interior offers antibacterial finish that wicks moisture away. Removable nose guard and chin curtain. Quick release visor mechanism. Lightweight unique reflective details at back. D.O.T certified and conform to ECE 22.05 (European regulation).

Shell: 100% multi-directional composite fiber reinforced with carbon and aramid fiber

Sizes: XS, S, S/M, M/L, L, XL
447325 - Silver (08), Black (90)

~~WAS \$399.99~~

NEW PRICE \$279.99

GSX-4 SERIES SINGLE PANE ROAD VISOR

100% Polycarbonate

One size

447380 - Clear (00),
Smoke 80% (20),
Smoke 60% (21),
Mirror Silver (22),
Mirror Multicolor (23)

\$69.99

FULL FACE HELMET CASE

Water-resistant shell biofoam construction. Self-healing nylon zippers. Quick access spare faceshield storage. External legs for vertical storage. Interior scratch-proof inner surface. Ergonomic soft touch rubber carrying handle. Fits all helmets.

One size

445856 - Black (90)

\$44.99

CAN-AM ST-3 OPEN FACE HELMET



SILVER (08)



BLACK (90)

- Good value for the money
- Stylish riding look
- D.O.T. approved

CAN-AM ST-3 OPEN FACE HELMET

Vent system on top. Double density inner shell. Non-allergenic and breathable internal lining. Clear, anti-scratch treatment. D.O.T. approved.

Shell: Polycarbonate Composite

Sizes: XS, S, M, L, XL, 2XL
447464 - Silver (08), Black (90)

\$89.99

SPYDER RT ROADSTER

ACCESSORIES

CHROME	32
LIGHTING	36
WINDSHIELD	36
ELECTRICAL (GPS, AUDIO SYSTEM)	37
CARGO & BAGS	39

RT-622 TRAILERS

TRAILERS	42
ACCESSORIES	43



SPYDER RS ROADSTER

SPORT ACCESSORIES

LIGHTING	46
BODY KIT & TRIMS	47
PERFORMANCE	
SILENCER	47
SEAT	48
WINDSHIELDS	48
BILLET	
ACCESSORIES	49

TOURING ACCESSORIES

COMFORT SEAT	50
FOOT PEGS	50
WINDSHIELDS	51
SPORT RACK & BACK REST	52
SADDLE BAG & BAGS	53



SPYDER RS WITH SPORT ACCESSORIES



SPYDER RS WITH TOURING ACCESSORIES

SPYDER RT

ROADSTER ACCESSORIES



RT CHROME ACCESSORIES

DRIVER FOOT PEGS
P.35

FOOT PEG SUPPORT CASTINGS
P.34

PASSENGER FLOORBOARDS
P.35

EXHAUST TIP
AND HEAT SHIELD
P.35

BRAKE PEDAL
P.35





WINDSHIELD SUPPORT
P.34

UPPER WIND DEFLECTORS
P.34

LOWER WIND DEFLECTORS
P.34

MIRRORS
P.34

HANDLEBAR COVER
P.34

HANDLEBAR END CAPS
P.34



WINDSHIELD SUPPORT

Chromed replacement model for a brilliant finish. Complete with new mounting hardware.

Spyder RT 219400298 - Chrome
\$299.99



FOOT PEG SUPPORT CASTINGS

Chromed upgrade dramatically changing the appearance of your RT. Sold in pairs, remounting hardware included. Peg and floorboard sets sold separately.

Spyder RT 219400268 - Chrome
\$579.99



UPPER WIND DEFLECTORS

Premium chrome version to replace stock model. Set of 2, hardware included.

Spyder RT 219400262 - Chrome
\$99.99



HANDLEBAR COVER

Dramatically changes the look of your handlebars. Complete with new hardware and black center cap.

Spyder RT 219400263 - Chrome
\$299.99



LOWER WIND DEFLECTORS

Premium chrome version to replace stock model. Set of 2, hardware included. Model year 2011 geometry.

Spyder RT 219400290 - Chrome
\$99.99



MIRRORS

Chrome accents to upgrade your mirrors. Sold in pairs.

Spyder RT 219400291 - Chrome
\$89.99



HANDLEBAR END CAPS

Set of 2.

Spyder RT 219400297 - Chrome
\$39.99

AIR INTAKE TRIMS

(Not illustrated)

Chrome detailing that makes your roadster stand out. Set of 2.

Spyder RT 219400196 - Chrome
\$119.99



EXHAUST TIP AND HEAT SHIELD

Kit for custom finishing your stock exhaust system. Includes chrome end pipe, heat shield and hardware.

Spyder RT 219400260 - Chrome
\$279.99



PASSENGER FLOORBOARDS

Complete chrome passenger floorboards assembled with rubber isolation pads. Sold in pairs, mounting hardware included.

Spyder RT 219400265 - Chrome
\$269.99



DRIVER FOOT PEGS

Chrome pegs assembled with rubber isolation pads. Sold in pairs, mounting hardware included.

Spyder RT 219400264 - Chrome
\$199.99



BRAKE PEDAL

Complements the rest of your roadster's chrome parts and accessories. Complete with rubber pad.

Spyder RT 219400267 - Chrome
\$129.99



SHIFT LEVER

Complements the rest of your roadster's chrome parts and accessories. Complete with rubber pad.

Spyder RT 219400266 - Chrome
\$99.99



LOWER SPOILER TRIMS

Chrome trims for replacing existing flat black parts. Set of 2. Standard on RT-S and RT Limited models.

Spyder RT 219400194 - Chrome
\$149.99



REAR SIDE CARGO TRIMS

Chromed left and right hand trims. Integrates nicely into rear side cargo. Standard on RT-S and RT Limited models.

Spyder RT 219400193 - Chrome
\$99.99



SIDE CAN-AM TRIMS

Replaces stock flat black parts with a splash of chrome. Can-Am branded. Set of 2. Standard on RT-S and RT Limited models.

Spyder RT 219400195 - Chrome
\$79.99



REAR TOP CARGO TRIM

Chrome trim that provides finishing touch to top cargo. Standard on RT-S and RT Limited models.

Spyder RT 219400192 - Chrome
\$79.99



WINDSHIELD TRIMS

Premium chrome trims for enhancing the look of your windshield. Replaces existing flat black parts. Set of 2. Standard on RT-S and RT Limited models.

Spyder RT 219400191 - Chrome
\$59.99



- Outstanding night visibility. Very close to natural light emitted by the sun.
- Less power energy consumption.
- 3 times more light on the road than conventional halogen headlights.



HID XENON LIGHTING SYSTEM

High and low beam system providing three times more light on the road than conventional halogen headlights. Revolutionary technology streams Xenon gas and other noble gases in tubes anchored between two high-voltage electrodes that emit a bright bluish white light when activated. Improves night visibility thanks to attractively cool and comfortable light very close to natural light emitted by the sun. *5-LED Front Headlamp Accent Lighting Kit (219400188) sold separately.*

Spyder RT 219400135
\$999.99

5-LED FRONT HEADLAMP ACCENT LIGHTING KIT

(Not illustrated)

Additional luminescence for improved visibility and more spectacular arrivals. Standard on RT-S and RT Limited models.

Spyder RT 219400188
\$149.99

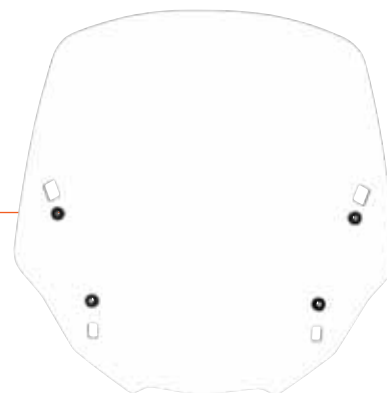

TOURING WINDSHIELD

Lower and narrower design for riders looking for less wind protection than provided by the stock RT model.

Spyder RT
H 23" (58.4 cm) x W 22" (55.8 cm): 219400243 - Clear
\$249.99

Optional Production Windshields

H 27" (68.5 cm) x W 25" (63.5 cm): 705003777 (Stock on MY10)
H 25" (63.5 cm) x W 24" (61 cm): 705004851 (Stock on MY11)

FOG LIGHTS

Enhances low beam light for better visibility at ground level and on sides. Uniquely styled halogen fog lamps feature a 35W bulb and clear lens with a faceted inner reflector. Easy installation. Standard on RT-S and RT Limited models.

Spyder RT 219400137
\$499.99

Ultimate GPS system designed specifically for bikers.

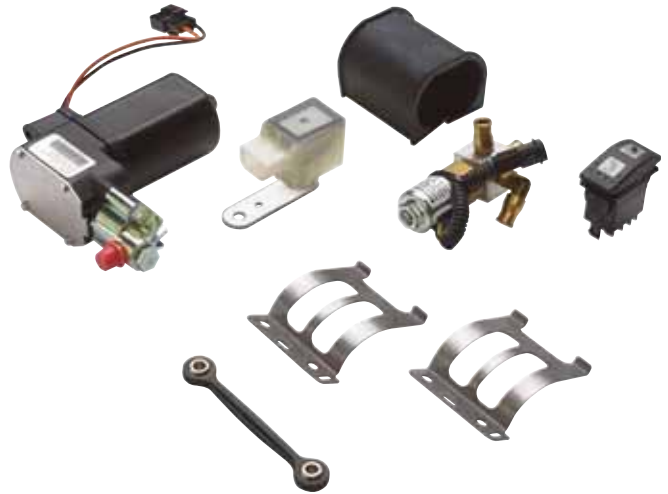

GPS NAVIGATION SYSTEM WITH SUPPORT

Garmin® Zumo® 660 with Bluetooth® capability and custom RT handlebar mounting cradle. Generously-lit and sunshine-readable 4.3 touchscreen color display eases navigation on a bright day or moonless night. Information appears in easy-to-read format. Glove-friendly intuitive interface with large buttons. Left-handed controls make entering information as easy as shifting gears. Rugged waterproof case resists fuel sprays and UV rays. Standard on RT Limited model.
Spyder RT 219400149
\$1,199.99

ADJUSTABLE AIR REAR SUSPENSION KIT

Upgrades suspension comfort to RT-S premium automated level. Includes air compressor, adjustment switch and all required hardware. Standard on RT-S and RT Limited models.
Spyder RT 219400323
\$449.99

ENTERTAINMENT HARNESS

(Not illustrated)

Harness required to install the CB & Communication System (219400145) and Satellite Radio Kit (219400148).
Spyder RT 219400201
\$109.99

GPS SUPPORT AND HARNESS

Support kit for Garmin Zumo 660. Includes casting, electric harness, rubber boot and hardware. GPS sold separately.
Spyder RT 219400318 - Painted Grey casting
\$149.99
219400322 - Chrome casting
\$219.99

IPOD® INTEGRATION CABLE

(Not illustrated)

Cable for hooking up an iPod to top cargo's DIN connector. Includes 5V transformer culled from latest-generation iPod. Full-feature handlebar control. DOT-Matrix visual interface. Driver volume control and playlist browser convenience through vehicle's cluster.
Spyder RT and RT Audio & Convenience 219400187
\$99.99

3.5 MM AUDIO PLAYER INPUT IN REAR TOP CARGO WITH HANDLEBAR VOLUME CONTROL

(Not illustrated)

3.5 mm cable for hooking up an MP3 player to top cargo's DIN connector. Driver volume control convenience through vehicle's cluster.
Spyder RT and RT Audio & Convenience 219400186
\$29.99

REPLACEMENT N-TOUCH COVERS FOR COMMUNICATION SYSTEM DIN CONNECTORS

(Not illustrated)

Spyder RT (service kit) 219400315 - Black
\$10.99

CB ANTENNA REPLACEMENT KIT

(Not illustrated)

Includes antenna, antenna base, ground strap and wires.
Spyder RT (service kit) 219400317
\$149.99





CB & COMMUNICATION SYSTEM

For staying in touch with friends across a range of 40 channels. Handlebar controls allow PTT and adjust squelch levels for maximum performance and reception quality. Fully integrated system also mutes radio while in transmitting and receiving modes. Plug and play system controlled via vehicle's cluster. AM/FM Radio (219400146) and Entertainment Harness (219400201) required for installation. Headset sold separately.

Spyder RT 219400145
\$799.99



AM/FM INTEGRATED AUDIO SYSTEM

Latest-generation portable integrated audio system with menu driven display. 6 AM and 10 FM radio presets, integrated weather band and weather alert warnings. Easy access handlebar controls, two front fairing speakers, antenna and speed compensating volume. System plugs and plays directly into vehicle wiring harness. Standard on RT Audio and Convenience, RT-S and RT Limited models.

Spyder RT 219400146
\$649.99



SATELLITE RADIO KIT

Receiver helps maintain radio reception everywhere. 150+ digital channels to choose from. 15 station presets for quickly tuning into your favorite programming. Plug and play system controlled via vehicle's cluster. Fee-based monthly subscription is required. AM/FM Radio (219400146) and Entertainment Harness (219400201) required for installation. Headset sold separately.

Spyder RT 219400148
\$449.99



PASSENGER SPEAKER & AUDIO CONTROLS

Concert sound quality rear speaker kit including speakers, pods and passenger controls for full radio tuning. Plugs and plays directly into vehicle. Fully-equipped wiring harness included in kit. Standard on RT-S and RT Limited models.

Spyder RT 219400150
\$149.99



FUEL & TEMP GAUGE POD

Adds custom touch to gauge pod. Set of 2. Comes standard on RT-S and RT Limited models.

Spyder RT 219400184 - Chrome
\$249.99



HEATED PASSENGER GRIPS

Complete passenger heating kit with variable intensity control. Provides extra warmth during cooler riding season. Standard on RT Audio and Convenience and RT Limited models.

Spyder RT 219400151
\$179.99



FRONT CARGO REMOTE ELECTRONIC UNLOCK

Convenient push-button electronic front hood release. Standard on RT-S and RT Limited models.

Spyder RT 219400185
\$89.99



FRONT CARGO 12-V POWER OUTLET KIT

Adds an extra 12-Volt power outlet to your vehicle. Conveniently located in front cargo bin.

Spyder RT 219400203 - Black
\$29.99

RT CARGO ACCESSORIES & BAGS



FRONT CARGO LINER

Felt insert provides finishing touch to front compartment. Features multiple storage pockets. Designed to integrate the front cargo light. Standard on RT-S and RT Limited models.

Spyder RT 219400166 - Black
\$149.99



TOP CASE MOLDED INSIDE LINER

Felt insert for finishing touch to rear top cargo compartment.

Spyder RT 219400246 - Dark Grey
\$119.99



REAR TOP CARGO SHELF

For supporting and organizing rear top cargo. 2 recessed compartments to hold electronic accessories. Can be tilted to facilitate access to lower section of cargo.

Spyder RT 219400232 - Black
\$49.99



SOFT FRONT CARGO TRAVEL BAG

Soft travel bag designed to maximize available front cargo space or to stow in the RT-622 trailer. Integrated handles for easy transport. Can also be used as a sport bag.

Spyder RT and RT-622 trailer 219400170 - Black
\$79.99



SEMI-RIGID MP3 PLAYER BAG

Semi-rigid bag with metal bracket to easily fit your audio player in the rear top cargo of your Spyder RT roadster. The protective faux leather bag can also accommodate your cell phone or other mobile digital devices. An opening on the side of the bag allows connection. You can ride and listen to music knowing your audio player is well protected. Can also be clipped at your waist.

Spyder RT 219400189 - Black
\$39.99



GLOVEBOX ORGANIZER

Removable leather organizer for conveniently storing money, credit cards, cell phone, pen, important documents, etc. Slips easily in front center glovebox.

Spyder RT 708300459 - Black
\$39.99

A complete collection of quality travel bags specially designed to fit your Spyder RT.



SEMI-RIGID FRONT CARGO TRAVEL BAG

Rolling travel bag designed to maximize available front cargo space. Can also double as airplane carry-on luggage. Standard on RT Limited model.

Spyder RT 219400167 - Black \$199.99



SEMI-RIGID REAR SIDE CARGO TRAVEL BAGS

Stylish premium travel bags specifically sized to fit in rear side cargo. Retractable handle and shoulder straps for carrying convenience. Integrated pull tabs for effortless removal from cargo cavity. Sold in pairs. Standard on RT Limited model.

Spyder RT 219400169 - Black \$229.99



SOFT SIDE CARGO TRAVEL BAGS

Soft travel bags that maximize Spyder RT rear side cargo space. Integrated handles for easy transport. "Y" logo. Sold in pairs.

Spyder RT 219400172 - Black \$54.99



SEMI-RIGID REAR TOP CARGO TRAVEL BAG

Stylish premium travel bag specifically sized to fit in rear top cargo. Retractable handle for carrying convenience. Integrated pull tabs for effortless removal from cargo cavity. Standard on RT Limited model.

Spyder RT 219400168 - Black \$99.99

SOFT REAR TOP CARGO TRAVEL BAG

(Not illustrated)

Soft travel bag designed to maximize rear top cargo space. Integrated handles for easy transport. "Y" logo. Rear Top Cargo Shelf (219400232) recommended for installation.

Spyder RT 219400171 - Black \$49.99



TOP CASE MIRROR

For rear top cargo cover. Folds open, locks up when not in use. Product will be available in Spring 2011. **Spyder RT 219400321 \$59.99**

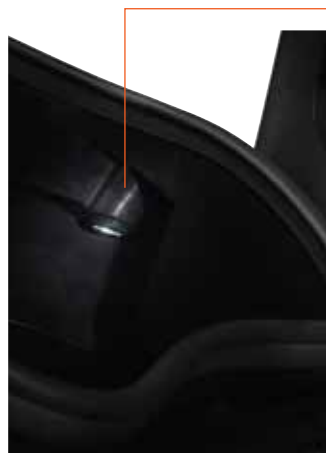

FRONT CARGO LIGHT

Convenient night time lighting for front cargo box. Light turns on as hood opens. To use front cargo light, vehicle must be equipped with electronic front cargo release (219400185). Standard on RT-S and RT Limited models. **Spyder RT 219400147 \$59.99**

RT-622 TRAILERS

The Spyder RT roadster platform is a natural for pulling a trailer. Its stance provides stability and a safe way to trailer the RT-622 on the open road. Nothing on the market compares with this innovative product.

KEY FEATURES

- Specifically designed for the Spyder RT.
- Calibrated to work with the Spyder RT's VSS system maximizing vehicle's handling dynamics.
- Can also match other vehicle using the 4 Pin Trailer Adaptor Harness (219400271).
- Fully loaded with 22 cu. ft. (622 liters) of cargo capacity.
- Coil over independent suspension.
- 12" vehicle matching cast aluminum mag wheels.
- Utilizes same RT integrated lighting system.
- Front and rear lids opening with vehicle matching key locks, gas shocks ease accessibility and maximize loading capabilities.
- Thermoformed and seamless fully carpeted interiors.
- Fiberglass body matched shell with integrated vehicle design and features.

RT-622 TRAILERS FOR SPYDER RT



MY 2010

Metallic Silver matching wheels

000T1AB00 - Orbital Blue
000T1AC00 - Full Moon Silver

Smoked Chrome matching wheels

000T1AA00 - Timeless Black
000T1AD00 - Orbital Blue

Warranty: 2 years.

\$3,999.99

MY 2011

Metallic Silver matching wheels

000T1BB00 - Orbital Blue
000T1BC00 - Pure Magnesium

Smoked Chrome matching wheels

000T1BA00 - Timeless Black
000T1BD00 - Orbital Blue
000T1BN00 - Pure Magnesium
000T1BP00 - Vegas White Pearl
000T1BR00 - Viper Red

Warranty: 2 years.

\$3,999.99

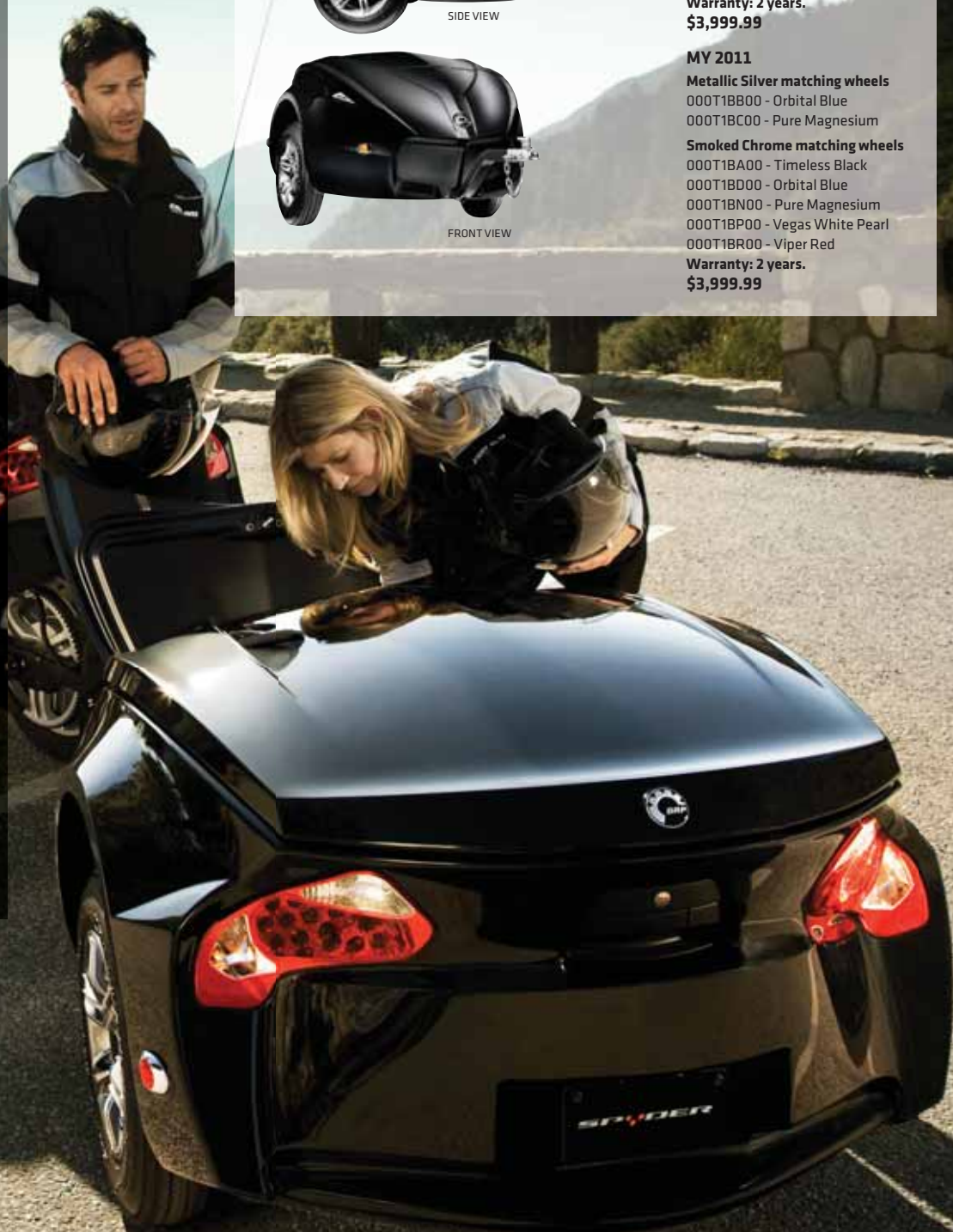



RT TRAILER HITCH KIT AND CONTROL MODULE

Heavy duty trailer hitch specifically designed for Spyder RT for use in conjunction with RT-622 trailer. Patent pending impact absorbing mechanical design ensures trailer and vehicle performance are maximized, and meet all stringent vehicle safety requirements. Integrated mud flap that reduce rock chips and other debris. Kit comes complete with wiring components and full-function light control module. Installs and removes easily.
Actual product may differ from image shown.
RT-622 219400144
\$499.99

Only system on the market that maintains vehicle warranty requirements.



METALLIC SILVER

SMOKED CHROME

SPARE WHEEL TIRE ASSEMBLY

12" custom replacement wheel assembly for the RT-622 trailer. Replicates stock RT design. Fits conveniently into the trailer spare tire recess for easy access.
RT-622 219400217 - Metallic Silver
RT-622 219400218 - Smoked Chrome
\$199.99



PROTECTIVE FILM (REPLACEMENT PART)

5 transparent decals to protect the lower front half of the trailer against road debris. Stock on unit.
RT-622 219400270 - Translucid
\$184.99



ROCK PROTECTOR (REPLACEMENT PART)

Rubber front trailer guard protects against road debris. Stock on unit.
RT-622 705004405 - Dark Grey
\$124.99



4 PIN TRAILER ADAPTOR HARNESS

Designed to convert trailer's electrical harness into a standard 4 pin trailer connector for automotive use. *Actual product may differ from image shown.*
RT-622 219400271
\$139.99



TRAILER TONGUE STAND

Keeps trailer leveled when not hitched to vehicle.
RT-622 219400190 - Black
\$94.99

RT-622 TRAILER ACCESSORIES



CARGO NET SYSTEM KIT

Complete RT-622 organizer kit. Three separator nets, two removable bags, and two floor tracks to stabilize your cargo inside the trailer.

RT-622 219400276 - Black
\$189.99



WATER MANAGEMENT KIT (REPLACEMENT PART)

Prevents water from infiltrating into cargo area when rear lid is open. Complete with integrated automatic drainage system. A must in wet conditions. Comes standard on MY11 units.

RT-622 219400300 - Black
\$69.99



SPARE WHEEL TIRE BAG

Spare tire transportation bag with integrated clipping system to secure tire in trailer. Can be used with the Cargo Net System Kit (219400276).

RT-622 219400307 - Black
\$54.99



CARGO LOAD STABILIZER

Plastic block system with Velcro® to help secure movable cargo in trailer while riding.

RT-622 219400280 - Black
\$34.99



INTERIOR TRAILER LIGHT

Battery operated high intensity LED light. Easily removable.

RT-622 219400277
\$69.99



KEY AND BARREL KIT

RT-622 219400180
\$34.99

SPYDER RS

ROADSTER ACCESSORIES





- Outstanding night visibility. Very close to natural light emitted by the sun.
- Less power energy consumption.
- 3 times more light on the road than conventional halogen headlights.

HID XENON LIGHTING SYSTEM

Our HID Xenon high and low beam lighting system provides revolutionary lighting for 3 times more light on the road compared to traditional halogen headlights. Each light uses a tube of Xenon gas, and small amounts of other noble gases, placed between two high-voltage electrodes that emit a bright bluish/white light when electrodes are activated. Quality German-made Hella¹ ballasts are used to regulate the flow of electricity providing a high intensity beam that never fluctuates. HID light consume only 35W of electricity making them over 3 times more efficient than traditional halogen bulbs. Attractive light is comfortable and very close to the natural light emitted by the sun. Improves night visibility.

Spyder RS 219400083

WAS \$1,069.99

NEW PRICE \$899.99

FOG LIGHTS

Enhances low beam light for better visibility at ground level and on the sides of your vehicle. Uniquely styled halogen fog lamps feature a 35-watt bulb and clear lens with a faceted inner reflector. Easy installation.

Spyder RS 219400084

\$449.99

COMBINATION HARNESS

(Not illustrated)

When combining the HID Xenon Lighting System (219400083) and the Fog Lights (219400084) on your Can-Am Spyder roadster, the following wiring harness adaptor is required.

Spyder RS 219400089

\$99.99

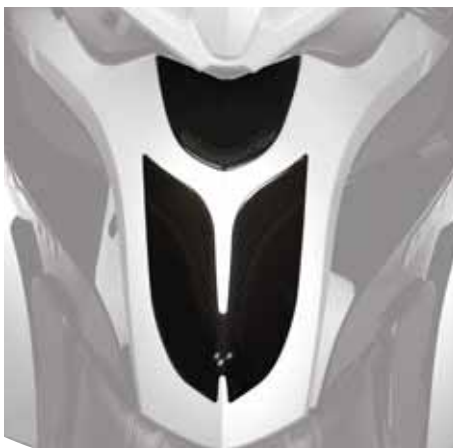

CONSOLE PROTECTOR

Two piece adhesive console protectors. Added protection that also changes the look of your console. Sold as a kit.

Spyder RS 219400131 - Black

\$49.99



CUSTOM HANDLEBAR GRIPS

Designed to provide a softer grip for added comfort and non-slip control. Sold in pairs.

Spyder RS 219400103 - Black

\$34.99



WIND DEFLECTOR KIT

Integrated lateral deflectors for extra body protection from the elements.

Spyder RS 219400164

\$199.99



Nothing brings out the sleekness and sophistication of a free-spirited vehicle like Phantom Black.

BODY KIT

In conjunction with the stock gloss panels, the flat black bodywork totally transforms your Spyder into an even leaner, meaner and stealthier *über* road warrior. Kit includes: rear fender, rear cap, center panel, left and right side panels, left and right front fenders, hood, front facing.

Spyder RS
219400090 - Phantom Black
\$999.99



PERFORMANCE SILENCER BY HINDLE[†]

Hindle exhaust system combines sporty looks with great sound. 40% lighter than stock pipe. Ceramic-coated. Additional 4 HP with the stock ECU file. Not street legal. *Disclaimer: This part is intended for closed-course racing applications only. Can-Am Spyder roadsters modified with the performance silencer are prohibited from usage on public roads, and can only be operated in closed-course competitions. Use of this component outside of closed-course competition events constitutes tampering under the US EPA and California Air Resource Board regulations and can lead to substantial fines and penalties.*

Spyder RS 219400073
\$629.99



PREMIUM GRAPHIC PACKAGE

2 Can-Am and 2 Spyder stickers. Chrome finish. 1.5 mm thick domed relief. Fit perfectly on vehicle. Easy to install.

Spyder RS 219400097
\$79.99

SIDE PANEL TRIM KIT

Provides additional side panel scratch protection while enhancing the look of your vehicle. Sold in pairs.

Spyder RS 219400078 - Black
\$109.99



CALIPER TRIM KIT

Can-Am Spyder branded red caliper brake inserts for added style. Self-adhesive and easy-to-install. Fit front brake calipers. Sold in pairs.

Spyder RS 219400074 - Red
\$20.99



RISER BLOCK

Increases height of handlebars for additional comfort and a more relaxed ride, especially for taller riders. 1" (25mm) cast aluminum construction. Works in conjunction with all stock wiring and cables.

Spyder RS 219400241 - Black
\$44.99



PROMOTIONAL STICKERS

Multi-use vinyl stickers. Ideal for showing your Spyder colors everywhere you go. Sold in packs of 4.

Spyder RS 219400099
\$24.99



RED



YELLOW



FULL MOON SILVER



MATTE BLACK



QUANTUM BLUE



VEGAS WHITE PEARL



STEEL BLACK METALLIC



PURE MAGNESIUM

MONO SEAT COWL

Sporty, color-matched cowling covers the passenger seat. Easy to install and remove.

Spyder RS

- 219400079 - Yellow
- 219400080 - Full Moon Silver
- 219400092 - Matte Black
- 219400093 - Red
- 219400234 - Quantum Blue
- 219400238 - Vegas White Pearl
- 219400272 - Steel Black Metallic
- 219400306 - Pure Magnesium

\$199.99

PAD KIT FOR MONO SEAT COWL
(Not illustrated)

Spyder RS (service kit)
219400138
\$5.99

STRAP KIT FOR MONO SEAT COWL
(Not illustrated)

Spyder RS (service kit)
219400107
\$9.99



CUSTOM SEAT SKIN

Top-quality seat skin features color-matched stitching and embossed "Y" logo. Integrated pre-drilled holes in seat base facilitate installation. Installs over stock seat skin with a push dart system in under 15 minutes.

Spyder RS

- 219400085 - Black / Yellow stitching
- 219400086 - Black / Grey stitching
- 219400100 - Black / Red stitching

\$209.99



ULTRASPORT WINDSHIELD

Makrolon[®] polycarbonate windshield with blackened-out «V» shape profile. 10" (25 cm) high. Easy installation.

Spyder RS 219400077 - Smoke
\$144.99



SPORT WINDSHIELD

Makrolon polycarbonate custom windshield. 10" (25 cm) high. Easy installation.

Spyder RS 219400076 - Clear
\$139.99



BILLET FOOTPEGS

Custom look design driver footpegs with weighted ends to reduce vibration. Match brake cover kit. Aluminum anodized black chrome. Sold in pairs.

FRONT: Spyder RS 219400117

REAR: Spyder RS 219400122

\$229.99



BILLET FRONT AXLE AND NUT KIT

Complete kit hides exposed front axle nuts and fender bolts all in one precision machined billet cover. Clean styling and brilliant anodized black chrome complement vehicle's front end. MY 2010 & prior.

Spyder RS 219400116

\$119.99



BILLET SWING ARM COVER

Billet aluminum variation anodized with black chrome. For replacing your existing plastic swing arm. Provides distinctive styling with engraved "Y" logo.

Spyder RS 219400111

\$109.99



BILLET BRAKE LEVER COVER KIT

Enhances look of footbrake and parking brake levers. Custom design matches billet footpegs. Aluminum anodized black chrome. Sold as a 2-cover set.

Spyder RS 219400118

\$94.99



BILLET FRONT SHOCK BOLT/NUT CAP KIT

Anodized black chrome. Billet bolt and nut covers. Complement matching front axle cover.

Spyder RS 219400110

\$99.99



BILLET ANTI-VIBE HANDLEBAR KIT

3" stainless steel weights complete with anodized black chrome billet engraved "Y" end caps. Reduces handlebar vibration. Gives a more finished look to your handlebar. Sold in pairs.

Spyder RS 219400115

\$99.99



BILLET REAR AXLE CAP KIT

Billet, black anodized covers with machined "Y" logo. Provides a clean customized look.

Spyder RS 219400113

\$99.99



BILLET SWING ARM END CAP KIT

Anodized black chrome. Billet end caps with contoured shape for replacing stock caps. Complete with machined "Y" logos. Sold in pairs.

Spyder RS 219400112

\$59.99



BILLET LICENSE PLATE FRAME

Manufactured from billet aluminum. Anodized black chrome license plate delivers a clean finished logo, complete with engraved Spyder logo.

Spyder RS

4" x 7" (10 cm x 18 cm): 219400114

\$89.99

4" x 8" (10 cm x 20 cm): 219400130

\$94.99



BILLET FRONT SHOCK ADJUSTER

Set of 2 lower front shock adjusters. Provides custom finish. Aluminum anodized black chrome.

Spyder RS 219400121

\$89.99



BILLET REAR SHOCK LOWER BOLT/NUT CAP KIT

Anodized black chrome. Custom billet covers. For use over rear shock bolt/nut for cleaner detailed look.

Spyder RS 219400109

\$59.99



COMFORT SEAT

Premium plush styling with stitched seat skin. Custom saddle look and new relaxed sitting position. Increases driver and passenger comfort and reduces tailbone pressure. Ideal for driving long distances. Sold as complete seat assembly.

Spyder RS 219400284 - Black
\$429.99

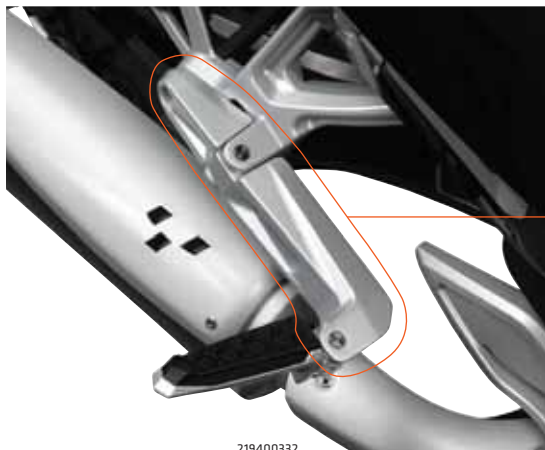

219400332

PASSENGER ERGONOMIC FOOT PEG EXTENSIONS

Peg extensions relax knee angle by stretching leg position downward and outward for a more comfortable ride during long trips. Pegs fold in conveniently when not in use. Utilize existing foot peg fixation point. Stock foot pegs reinstall into the new extensions. Sold in pairs.

Spyder RS 219400332

Color matched to the new MY11 RS-S castings. Sold in pairs.

Spyder RS 219400333 - Carbon Black
\$219.99



219400333



GPS SUPPORT

Universal GPS support. Suitable for most GPS systems that can adapt to a 1" (25 mm) RAM® mount ball. Includes hardware. GPS not included.

Spyder RS 219400331 - Black
\$154.99

12-V POWER OUTLET KIT

(Not illustrated)

12-Volt kit provides on-the-go power to charge electrical products such as your cell phone or GPS.

Spyder RS 710001316
\$29.99



EXCLUSIVE PROMOTION

ON RS TOURING COMFORT ACCESSORIES BUNDLE*

SPECIAL PRICE \$799**
REGULAR PRICE \$924

Designed specifically for RS riders who want comfort for extended escapes.

Kit includes:

- 23" (58.4 cm) Ultra Touring Windshield (219400129);
- Comfort Seat (219400284);
- 12-V Power Outlet Kit (710001316);
- Tank Bag (280000318);
- Riser Block (219400241).

Spyder RS - 219800190
\$799.00

*The picture represents a fully accessorized unit.



SPORT / TOURING WINDSHIELD

Makrolon polycarbonate custom windshield. 14" (36 cm) high for optimal protection.

Spyder RS - 219400075 - Clear
\$174.99

**Only at participating Can-Am Spyder dealers.



23" (58.4 cm)



25" (63.5 cm)

ULTRA TOURING WINDSHIELD KIT

The complete wind and weather system. Windshield and integrated side deflector system provides maximum upper and lower screening protection. Made of Quantum¹ hardcoated 4.5 mm Lexan¹ polycarbonate. Reduces turbulence for long distance comfort. Utilizes existing mounting points for clean finish and easy install.

Spyder RS

Size ideal for drivers 5'10" (1.75 m) tall and under.

23" (58.4 cm): 219400129 - Clear

Size ideal for drivers over 5'10" (1.75 m) tall.

25" (63.5 cm): 219400177 - Clear

\$319.99



INTEGRATED SIDE DEFLECTORS ADD TO FULL-BODY RIDER AND PASSENGER WIND PROTECTION. INCLUDED WITH ULTRA TOURING WINDSHIELD.

ULTRA TOURING WINDSHIELD FASTENERS KIT

(Not illustrated)

Spyder RS (service kit) 219400204

\$20.99

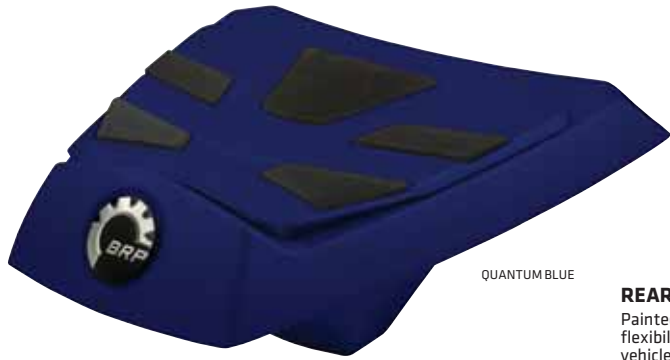

QUANTUM BLUE



STEEL BLACK METALLIC



FULL MOON SILVER



RED



YELLOW



MATTE BLACK



VEGAS WHITE PEARL



PURE MAGNESIUM

REAR SPORT RACK

Painted cast-aluminum. Adds touring flexibility while complementing the vehicle's design lines. 0.75-liter storage inside. Usable in conjunction with adjustable backrest via unique locking mounting system. Provides additional luggage space when combined with rear rack bag.

Spyder RS

- 219400081 - Full Moon Silver
- 219400128 - Yellow
- 219400228 - Quantum Blue
- 219400229 - Vegas White Pearl
- 219400254 - Steel Black Metallic
- 219400101 - Red
- 219400294 - Matte Black
- 219400303 - Pure Magnesium

\$419.99

REAR SPORT RACK LID

(Not illustrated)

Spyder RS (service kit)

- 219400141 - Full Moon Silver
- 219400142 - Roadster Red
- 219400143 - Yellow
- 219400159 - Deep Black
- 219400230 - Quantum Blue
- 219400231 - Vegas White Pearl
- 219400255 - Steel Black Metallic
- 219400295 - Matte Black
- 219400304 - Pure Magnesium

\$79.99



VEGAS WHITE PEARL

ADJUSTABLE BACKREST

Cast-aluminum construction with polyurethane padding. Blends perfectly with vehicle design. Offers additional passenger comfort with up to 2" (5 cm) forward and rear adjustment. Easily removable when not in use. Easily clicks into Rear Sport Rack. *Rear Sport Rack is the base fixture for the backrest and is required to install the Adjustable Backrest.*

Spyder RS

- 219400140 - Full Moon Silver
- 219400155 - Yellow
- 219400226 - Quantum Blue
- 219400227 - Vegas White Pearl
- 219400253 - Steel Black Metallic
- 219400156 - Red
- 219400296 - Matte Black
- 219400305 - Pure Magnesium

\$264.99



FULL MOON SILVER

YELLOW

QUANTUM BLUE

STEEL BLACK METALLIC

RED

MATTE BLACK

PURE MAGNESIUM





R-35 RIGID SADDLEBAG KIT

Provides carry-away convenience for additional luggage storage. Clean finish courtesy of fully integrated flush mount racking with quick release system. Quick release quarter-turn system provides security and instant removal in minutes when saddlebags not required. Side case utilizes Monokey™ side fitting system. Opens/closes and attaches/detaches with one key + push button for ease of use. Volume capacity 34 liters (e.g. fits 2 full face helmets). Weight capacity 22 lb (10 kg) each side. Dimensions (WxDxH) 21" x 12" x 15.5" (53 cm x 30 cm x 39 cm). Sold in pairs. Color-matched panels sold separately.

Spyder RS 219400301 - Black
\$869.99



SADDLEBAG LINERS

Soft inner liner bags that maximize storage space in the Spyder RS R-35 rigid saddlebag kit. *Sold in Canada only.*

Spyder RS 219400198 - Black
\$89.99

R-35 SADDLEBAG REAR REFLECTOR KIT

(Not illustrated)

Spyder RS (service kit) 219400235
\$12.49



R-35 SADDLEBAG PANEL KIT

Color-matched panels for R-35 Rigid Saddlebag Kit. Sold in pairs.

Spyder RS
 219400174 - Yellow
 219400175 - Red
 219400178 - Full Moon Silver
 219400176 - Black
 219400222 - Vegas White Pearl
 219400223 - Quantum Blue
 219400292 - Pure Magnesium
 219400293 - Alloy Orange
\$129.99



SPYDER ROLLING TRAVEL BAG

Premium bag with extendable handle. Fits conveniently in front storage compartment. Can be used with or without the trunk liner (280000319).

Spyder RS 219400098 - Grey
\$199.99





PASSENGER SEAT BAG

22.3-liter capacity (5.9 US gallons). Durable 1200-denier nylon construction with polyurethane coating. For use on passenger seat or fits in the front storage compartment. Finished with custom chrome Can-Am tags.

Spyder RS
280000320 - Dark Grey
\$134.99



TRUNK LINER

44-liter capacity (11.6 US gallons). Features multiple storage pockets and 12-V power access. Felt insert provides the finishing touch to the front compartment.

Spyder RS 280000319 - Black
\$134.99

FRONT TRUNK RELEASE

(Not illustrated)
Spring loaded system allowing front hood to pop open once ignition key has been turned.

Spyder RS 219400242
\$5.99



REAR RACK BAG

6.8-liter capacity (1.8 US gallons). Durable 1200-denier nylon with polyurethane coating. Use in conjunction with the rear sport rack. Easy to install and remove. Can-Am tags.

Spyder RS
280000317 - Dark Grey
\$99.99



TANK BAG

4.7-liter capacity (1.2 US gallons). Durable 1200-denier nylon construction with polyurethane coating. Easy to install and remove. Can-Am tags.

Spyder RS
280000318 - Dark Grey
\$104.99



COVERS

CUSTOM VEHICLE COVER

Made of tough water repellent 300-denier polyester that allows for breathability. This 2-tone cover provides maximum vehicle protection while trailering or outdoor storage. Includes integrated exhaust panel and protective flannel windshield liner. Easy attach system secures cover in all trailering conditions.

Spyder RT 219400173 - Black
\$219.99



OUTSIDE STORAGE COVER

Durable solution-dyed UV and mildew-resistant 100-denier polyester construction. Inner liner protects hood and windshield. Easy maintenance. For outdoor storage only.

Spyder RS 219400197 - Black
Fits RS models with Ultra Touring Windshield and Backrest.
\$199.99

Spyder RS 280000337 - Black
Fits RS models without Ultra Touring Windshield and Backrest (windshields up to 14").
\$174.99



LIGHT TRAVEL COVER

Provides vehicle's seating, handlebar and windshield areas with outdoor temporary/overnight protection. Compact size makes it convenient for traveling.

Spyder RS 219400275 - Black
\$149.99

INDOOR STORAGE COVER

Soft, non-abrasive, breathable polyester construction allows condensation to escape when vehicle is in storage. Easy clean fabric with Scotchguard[®] treatment. For indoor storage only.

Spyder RS 280000338 - Black
\$149.99



RT-622 TRAILER STORAGE COVER

Durable solution-dyed UV and mildew-resistant 100-denier polyester construction. An effective way to protect your trailer indoors or out, stores easily when on a road trip. Strictly for storage.

RT-622 219400216 - Black
\$119.99

TRAVEL COVER

Stows conveniently into top cargo and takes up little space. Quick installation and removal. Provides protection to vehicle's top areas, i.e. windshield, seats, top cargo. Standard on RT Limited model.

Spyder RT 219400199 - Black
\$124.99

WHEELS



RS-S MAG WHEELS

Premium cast aluminum construction. Provides custom look for RS models. For RS and RS-S models only. Sold in pairs.

Spyder RS

Same design as RS-S wheels, with Metallic Grey finish.

219400313 - Metallic Grey

\$519.99

219400325 - Carbon Black (Standard on MY11 RS-S model)

\$549.99



PHANTOM CUSTOM WHEEL KIT

6 large-spoke front alloy wheels. Painted black. For RS and RS-S models only. Sold in pairs.

Spyder RS 219400104 - Phantom Black

\$549.99



REAR RIM WITH WHEEL HUB

Production rear wheel and hub painted black to match Phantom black front custom wheel kit and sprocket cover. Wheel and hub sold as kit.

Spyder RS 219400105 - Black

\$359.99



6-SPOKE CUSTOM WHEEL KIT

Sleek, stylish custom front wheels incorporate the strength of 6 spokes into a lightweight design. Premium quality cast aluminum construction. Polished spokes radiate from the center to an outer gloss black rim. Sold in pairs. For RS and RS-S models only.

Spyder RS 219400071 - Grey

\$519.99



RT SMOKED CHROME WHEEL KIT

Premium wheels featuring 6-spoke with uniquely rounded smooth edge design. Quality cast aluminum construction reduces weight without compromising strength. Smoked chrome finish. Standard on RT-S and RT Limited models. For RT models only. Sold in pairs.

Spyder RT and RT Audio & Convenience 219400205 - Smoked Chrome

\$599.99



PHANTOM REAR SPROCKET COVER

Custom rear sprocket cover with the same flowing curves as the Phantom Custom Wheel Kit (219400104), for a complete custom look. Conveniently mounts over the stock sprocket.

Spyder RS 219400106 - Black

Spyder RS 219400219 - Black

Fits latest version of rear sprocket (705500860).

\$99.99

SPROCKET COVER REPLACEMENT FASTENER KIT

(Not illustrated)

Spyder RS & RT (service kit) 219400316

\$14.99



OILS & MAINTENANCE



XPS ROADSTER CLEANING AND DETAILING KIT

Includes multi-surface Metal Polish, degreasing Roadster Wash, showroom shine Spray Cleaner & Polish, super absorbent and machine washable Microfiber Towels.

219701712

\$42.49



XPS ROADSTER WASH

A green degreaser that removes dirt and road grime better than any other cleaner. Simply spray on and rinse off. When used as directed, XPS Roadster Wash is safe for all roadster finishes and is biodegradable and non-toxic.

219701703

\$10.99



XPS METAL POLISH

Cleans, polishes and protects most metal surfaces, such as chrome, stainless steel, nickel, aluminum, brass, bronze, copper, platinum, magnesium and more. (Not recommended for use on anodized or clear-coat finishes.)

219701707

\$14.99



XPS SPRAY CLEANER & POLISH

Removes road grime, dirt, grease and bugs from land vehicles as well as scum lines and water marks from watercraft. Spray on then buff out, without water. When used as directed, it leaves a showroom shine that protects against sun damage, ozone damage and dirt accumulation. XPS Spray Cleaner & Polish works great on painted surfaces, fiberglass, chrome and plastics found on your watercraft, motorcycles, snowmobiles and more.

219701706

\$9.99



XPS BRAKES & PARTS CLEANER

A concentrated blend of solvents with a powerful blasting spray that effectively removes grease, grime, brake fluid and other contaminants from brake components and metal parts without the need for disassembly. This brake and parts contact cleaner evaporates instantly and completely leaving no residue to hinder performance. Contains no ozone depleters.

219701705 (US)

219701776 (CA)

\$7.99



XPS MICROFIBER TOWELS

The latest in high-quality detailing towels. Made up of extremely fine fibres, their soft surfaces have been perfected for drying and polishing boats, motorcycles, cars or any shiny finish. XPS Microfiber Detailing Cloths are so absorbent they hold up to seven times their weight in water. Machine washable means they can be used over and over again.

219701759

\$8.49



XPS 4-STROKE BLEND OIL - SUMMER GRADE

Synthetic blend 4-stroke engine oil for the Rotax 4-TEC engine. XPS summer grade synthetic blend on-road vehicle engine oil is a high performance oil developed for riders that demand maximum engine performance and protection during all operating conditions.

1 quart / 946 ml - 293600121
1 US gallon / 3.785 L - 293600122



XPS 4-STROKE OIL CHANGE KIT

Complete maintenance right out of the box: O-Ring, XPS oil, Rotax oil filter and instruction sheet.

SM5 - 219800207
SE5 - 219800208



XPS DOT 4 BRAKE FLUID

Exceeds DOT 3 and 4 requirements. Unique low-moisture formulation providing maximum protection against vapor lock. Recommended in Ski-Doo snowmobiles and Can-Am on-road vehicles.

293600131
\$4.99



XPS 4-STROKE SYNTHETIC OIL - ALL CLIMATE GRADE

Unlike other ordinary 4-stroke motor oils, XPS all climate grade synthetic 4-stroke oil is specifically engineered to meet the particular lubrication requirements of the Can-Am on-road vehicles equipped with Rotax 4-TEC™ 4-stroke engines. Provides easier starting in very cold temperatures.

1 quart / 946 ml - 293600112
1 US gallon / 3.785 L - 293600115



PRE-MIXED ANTIFREEZE/COOLANT

Pre-mixed ready to top up your coolant level. Blended to perform best in our Rotax engines with anti-corrosive additive.

219700362
\$7.49



FUEL STABILIZER

Fuel additive to protect against fuel contamination and residue build-up in carburetors and gas lines. Should always be used before storing your Can-Am on-road vehicle. Suitable for all gasoline engines.

413408601
\$8.49

Your Spyder is an original, and it requires original equipment manufacturer parts.

PART NUMBER	DESCRIPTION	PRICE
420256452	OIL FILTER	\$11.49
420956745	OIL FILTER - ELECTRONIC SHIFTING	\$15.49
705501154	BELT	\$299.99
705501312	REAR TIRE	\$149.99
219800164	FRONT BRAKE PAD KIT	\$110.99
219800165	REAR BRAKE PAD KIT	\$49.99
706201292	FRONT TIRE	\$74.99
707800188	AIR FILTER GS/RS	\$31.99
707800306	AIR FILTER RT	\$15.99
219800056	FUEL FILTER	\$14.99



PRIME TLC FOR YOUR CAN-AM SPYDER

ORIGINAL EQUIPMENT MANUFACTURER AND MANUFACTURER RECOMMENDED PRODUCTS & KITS

You own a Can-Am Spyder because you demand the very best from your machine. Take care of your roadster by maintaining it using strictly BRP and Rotax OEM or 100% Can-Am approved parts and products, and enjoy levels of performance that make every Can-Am Spyder ride or functional application a uniquely original experience.

LICENSED PRODUCTS



CAN-AM SPYDER LICENSE PLATE

Made of stainless steel with mirror finish. Raised letters to give 3D look. Thicker and more durable. Universal to fit all vehicles. 4849620008



CAN-AM SPYDER PARKING SIGN

12" X 18" (30 cm x 46 cm) made of white aluminum. Round corners and two holes for hanging. CA10A20001



CAN-AM SPYDER HITCH PLUG

Gives trucks, SUVs custom finished look. Keeps dirt, snow and other debris out of receiver. Fits 2" (5 cm) receivers. 4849520008



CAN-AM SPYDER STAINLESS STEEL TRAVEL MUG

14 oz. (414 ml) leak proof travel mug with double wall vacuum insulation. Keeps liquids hot or cold for extended time. Comfortable rubber handle with a key hook. CS08A20008



CAN-AM MULTI-TOOL

High-Sierra® 15-function multi-tool. Includes can and bottle opener, phillips head screw driver, 3 driver bits (2 - 4 mm), 3 blades (3 - 5 mm), serrated blade, pliers, needle nose pliers, wire cutter and dual-function file. CA08A60090



CAN-AM SPYDER RADIO CONTROL ROADSTER

18" (46 cm) Radio Controlled Can-Am Spyder roadster with rider. Modelled after the head-turning design-forward Can-Am Spyder. Full function forward and reverse drive with left and right steering. For indoor and outdoor use on smooth surfaces. Rechargeable battery system included. Ages 8 & up. 6103900030



CAN-AM SPYDER LAPTOP BACKPACK

Two main compartments. Yoke style shoulder straps. Fits most 17" laptops. Built-in audio pocket with headphone pass-through. 24" H x 14" W x 7" D (60 cm x 36 cm x 18 cm). CA10A10090



For additional information or to purchase these items, please contact your nearest BRP dealer.

STORE.SPYDER.BRP.COM

IT'S FAST, IT'S CONVENIENT AND IT'S ONLINE NOW!

CAN-AM SPYDER HOME | LANGUAGE | MY ACCOUNT | CONTACT US | ONLINE STORES

can-am



RIDING GEAR

ACCESSORIES

MAINTENANCE

PARTS



STORE E-NEWS

Stay informed with the latest news

SIGNUP »



CHECKING FOR SPYDER ACCESSORIES & RIDING GEAR... WELCOME HOME!!

Home to the official Can-Am Spyder roadster on-line store filled with genuine parts, accessories and riding gear brought to you by the same people who built your roadster. It doesn't get any better!

The exciting new 2011 parts, accessories and clothing Spyder line-up will be available for purchase in Winter 2011, both **online** and at your **authorized Can-Am Spyder dealer!**

**STAY CONNECTED WITH THE LATEST, NEWEST, HOTTEST SPYDER GEAR:
SIGN UP FOR OUR PROMO E-NEWS.**