



2011

PARTS, ACCESSORIES & RIDING GEAR

can-am



PARTS & ACCESSORIES

COMMANDER™ SIDE-BY-SIDE VEHICLE

MAKE IT YOUR OWN	4
UNDERBELLY PROTECTION	6
BUMPERS	7
WINDSHIELDS	9
ROOF ACCESSORIES	10
LIGHTS ACCESSORIES	11
WHEELS & PLOW	12
HITCHES & WINCHES	14
MULTI-FIT	15



2011

OFF-ROAD RIDING GEAR

RACE	16
LADIES' RACE	20
ADVENTURE	22
RECREATIONAL	26
SPORTSWEAR	28
BAGS & GOOGLES	32
HELMETS & ACCESSORIES	33
XP-2 / XC-1	34
XP-R	35
ST-1 / ST-3	36
VISION 180°	37
BV2S	38
MODULAR 2	39
BALACLAVAS	40
SIZING CHART	40



MAKE IT YOUR OWN



SPORT ACCESSORIES



UTILITY ACCESSORIES



WINTER ACCESSORIES



A-ARM PROTECTORS ▶ P.6 / TRAILING ARM PROTECTORS ▶ P.6 / LATERAL SKID PLATES ▶ P.6 /
 FRONT SKID PLATE ▶ P.6 / CENTRAL SKID PLATE ▶ P.6 / REAR SKID PLATE ▶ P.6 /
 FOX[†] PERFORMANCE FRONT SHOCKS ▶ P.6 / FOX PERFORMANCE REAR SHOCKS ▶ P.6 / FRONT XT BUMPER ▶ P.7 /
 HALF WINDSHIELD ▶ P.9 / SPORT VISOR ▶ P.10 / ROOF MIDDLE SECTION ▶ P.10 /
 LIGHT RACK FOR SPORT VISOR ▶ P.11 / HALOGEN OR HID LIGHTS ▶ P.11 / XT SPORT STEERING WHEEL ▶ P.15 /
 ROCK SLIDER ▶ P.15 /

A-ARM PROTECTORS ▶ P.6 / TRAILING ARM PROTECTORS ▶ P.6 / LATERAL SKID PLATES ▶ P.6 /
 FRONT SKID PLATE ▶ P.6 / CENTRAL SKID PLATE ▶ P.6 / REAR SKID PLATE ▶ P.6 / FRONT XT BUMPER ▶ P.7 /
 OFF-ROAD XTREME FRONT-BUMPER ▶ P.7 / FRONT LIGHT PROTECTION ▶ P.7 / FRONT RACK ▶ P.7 /
 REAR BUMPER ▶ P.8 / LOWER TAILGATE PROTECTOR ▶ P.8 / XT FENDER FLARES ▶ P.8 / FULL WINDSHIELD ▶ P.9 /
 SPORT VISOR ▶ P.10 / ROOF MIDDLE SECTION ▶ P.10 / LIGHT RACK FOR SPORT VISOR ▶ P.11 /
 HALOGEN OR HID LIGHTS ▶ P.11 / MULTIMOUNT WINCH KIT ▶ P.13 / FRONT 2" RECEIVER HITCH ▶ P.13 /
 RT40 WARN[†] WINCH KIT ▶ P.14

A-ARM PROTECTORS ▶ P.6 / TRAILING ARM PROTECTORS ▶ P.6 / LATERAL SKID PLATES ▶ P.6 / FRONT SKID PLATE ▶ P.6 /
 CENTRAL SKID PLATE ▶ P.6 / REAR SKID PLATE ▶ P.6 / FRONT XT BUMPER ▶ P.7 / OFF-ROAD XTREME FRONT-BUMPER ▶ P.7 /
 FRONT RACK ▶ P.7 / REAR BUMPER ▶ P.8 / FULL WINDSHIELD ▶ P.9 / SPORT VISOR ▶ P.10 /
 ROOF MIDDLE SECTION ▶ P.10 / LIGHT RACK FOR SPORT VISOR ▶ P.11 / HALOGEN OR HID LIGHTS ▶ P.11 /
 SUPER DUTY PLOW ▶ P.12 / MULTIMOUNT WINCH KIT ▶ P.13



UNDERBELLY PROTECTION

FRONT SKID PLATE

Draw-formed 5052-H32 aluminum front skid plate provides essential protection. $\frac{3}{16}$ " thick for durability and strength. Commander, Commander X, Commander XT - 715000692
\$159.99

A-ARM PROTECTORS

5052-H32 aluminum A-arm plates and plastic deflectors provide essential protection and aggressive look. Engraved Can-Am logo. $\frac{3}{16}$ " thick for durability and strength. Sold in pairs. Commander, Commander X, Commander XT - 715000660
\$164.99

LATERAL SKID PLATES

Draw-formed 5052-H32 aluminum lateral skid plates provide essential protection. $\frac{3}{16}$ " thick for durability and strength. Engraved Can-Am logo. Sold in pairs. Commander, Commander X, Commander XT - 715000950
\$229.99

CENTRAL SKID PLATE

5052-H32 aluminum, $\frac{3}{16}$ " thick. Pre-cut holes for fluid and mud drainage, and servicing access. Engraved Can-Am logo. Direct replacement of factory installed plastic skid. Commander, Commander X, Commander XT - 715000693
\$314.99

REAR SKID PLATE

5052-H32 aluminum, $\frac{3}{16}$ " thick. Provides additional protection to rear end of vehicle. Engraved Can-Am logo. Direct replacement of factory installed plastic skid. Commander, Commander X, Commander XT - 715000694
\$114.99

TRAILING ARM PROTECTORS

5052-H32 aluminum trailing arm plates and plastic deflectors provide essential protection. Engraved Can-Am logo. $\frac{3}{16}$ " thick for durability and strength. Sold in pairs. Commander, Commander X, Commander XT - 715000661
\$149.99



FOX PERFORMANCE FRONT SHOCKS

Fox Piggyback racing shocks. Includes rebound and high/low speed compression adjustments. Sold in pairs. 715001022
\$999.99



FOX PERFORMANCE REAR SHOCKS

Fox 2.0 Position Sensitive racing shocks. Includes rebound and high/low speed compression adjustments. Sold in pairs. 715001023
\$1,111.99



AIR INTAKE PRE-FILTER

Add extra protection to your engine in harsh riding conditions. Filter blocks particles larger than 0.005". 715000953
\$39.99



BUMPERS

OFF-ROAD XTREME FRONT BUMPER

Delivers additional heavy duty protection that works with or without the front XT bumper. Textured black electrocoated for durability and rugged style.

Can-Am logo tag.
Commander, Commander X, Commander XT
 715000951
\$299.99

FRONT XT BUMPER

Made of heavy gauge steel for additional protection. XT styled for matching appearance. Textured black electrocoated for durability and rugged style. Effortless mounting.

Commander
 715000958
\$219.99

FRONT RACK

Durable finish for scratch resistant performance. Equipped with genuine Can-Am casted clamps for easy mounting on required XT bumper (sold separately). Does not limit access to air filter or cooling.

75 lbs load capacity.
 715000985
\$299.99

FRONT LIGHT PROTECTION

Works in conjunction with XT bumper, offering protection to front headlights and sporting aggressive look. Textured black electrocoated for durability and rugged style. Integrated Can-Am fastening system provides efficient mounting vs traditional P-clamps.

Commander, Commander X, Commander XT
 715000656
\$159.99



RADIATOR PROTECTOR

Black epoxy electrocoated metal shield that mounts over radiator face to provide protection from stones and branches.

Commander, Commander X, Commander XT
 715001126
\$64.99



BUMPERS

LOWER TAILGATE PROTECTOR

Aluminum body plating covering lower tailgate provides additional protection and aggressive look. Commander, Commander X, Commander XT except CE version
715001097
\$89.99



XT FENDER FLARES

Deliver aggressive look while providing added protection from dirt and debris. Standard on XT models. Includes front and rear extensions and all mounting hardware.
715001013
\$199.99



ALLOWS TO OPEN LOWER TAILGATE

REAR BUMPER

Integrated tubular system provides sporty look while protecting vehicle's bodywork. Flips with cargo box and lower tailgate. Commander, Commander X, Commander XT
715000657
\$249.99



XT BOX RAILS

Add integrated tie down area to your cargo box while enhancing the look. Textured black finish.
715000957
\$99.99



HALF WINDSHIELD

Designed for protection from wind and debris as well as optical clarity. This rugged, durable polycarbonate construction offers better impact resistance than acrylic windshields. Features reverse angle lip to deflect air flow. Non yellowing, non crazing, non cracking and UV resistant properties. Quick-attach brackets procure fast, easy and tool-less installation and removal.

Commander, Commander X, Commander XT
715000954
\$229.99

WINDSHIELDS



FULL WINDSHIELD - HARDCOATED

Combines the utmost in protection from the elements with optical clarity while riding. Hardcoated (both sides) polycarbonate material offers excellent impact and abrasion resistance, as well as prolonged protection against wear-and-tear for longer "like new" look than acrylic windshields. Non yellowing, non crazing, non cracking and UV resistant properties. Quick-attach brackets procure fast, easy and tool-less installation.

Commander, Commander X, Commander XT
715001177
\$529.99

FULL WINDSHIELD

Designed for optical clarity and better impact resistance than acrylic windshields thanks to durable polycarbonate construction. Non yellowing, non crazing, non cracking and UV resistant properties. Quick-attach brackets procure fast, easy and tool-less installation and removal.

Commander, Commander X, Commander XT
715000664
\$369.99



ROOF ACCESSORIES

ROOF MIDDLE SECTION

Ultimate in protection, style and integration. Twinsheet HDPE manufacturing delivers premium look, and complete coverage when combined with Sport Visor. Quick-attach bracket procures fast, easy and tool-less installation and removal.

Commander, Commander X, Commander XT
 715001176 Yellow
 715000655 Black
\$499.99

SPORT VISOR

Aggressive designed, twinsheet HDPE sport visor complete with integrated driver and passenger inner storage pockets. Required for installation of Can-Am light rack system. Complete with integrated light switch knock outs. Creates full roof for maximum element protection when combined with the roof middle section. Easy installation and removal. Can be used in conjunction with any windshield.

Commander, Commander X, Commander XT
 715000762
\$299.99



PANORAMIC CENTER MIRROR

Convex mirror for wide angle visibility. Can be used with or without roof and windshields. Light switches not included. Sport Visor sold separately.

715000956
\$74.99

LIGHTS ACCESSORIES



HID LIGHTS

Incomparable and powerful HID long range illumination plug-and-play system converts night usage into virtually daytime riding. Integrated ballast unit with 3.25" clear glass lens and swivel mounting heavy-duty bracket provides compact design. Water and dust proof IP67 and IP6K9K. Highest electromagnetic compatibility rating, i.e. EMC Class 5 according to CISPR 25, for total disturbance-free electronic operation. Peak light performance with just 35W. Luminous flux is 2.5 times higher than conventional halogen bulb with 35% less energy consumption. High vibration resistance with 5 times longer lifetime than halogen bulb. Constant light intensity even under unsteady power supply voltage. Includes basic wiring and switch. Works in conjunction with halogen and/or HID lights separately or in combination without overloading your charging system. Must be used with Light Rack for Sport Visor (715000910) and Sport Visor (715000762). Roof Accessories and Light Wiring Kit (715000987) is required to install the HID lights. Sold in packs of 2.

Commander, Commander X, Commander XT - 715000836
\$899.99



HALOGEN LIGHTS

Delivers long range illumination. Integrated ballast unit with 3.25" clear glass lens and swivel mounting heavy duty bracket provides compact design. Includes basic wiring and switch. Works in conjunction with halogen and/or HID lights separately or in combination without overloading your charging system. Must be used with Light Rack for Sport Visor (715000910) and Sport Visor (715000762). Roof Accessories and Light Wiring Kit (715000987) is required to install the halogen lights. Sold in packs of 2.

Commander, Commander X, Commander XT - 715000909
\$169.99

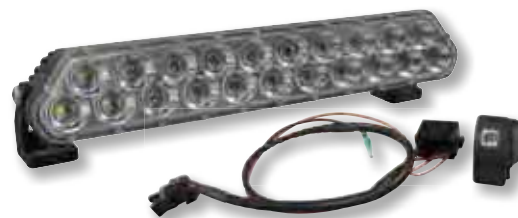

LED LIGHT BAR

Plug-and-play 21 LED x 5w 6300 lm system for premium long and close range illumination. Water and dust proof IP67. Heavy-duty, with 50,000 hrs durability. Includes basic wiring and switch. Must be used with Light Rack for Sport Visor (715000910) and Sport Visor (715000762). Roof Accessories and Light Wiring Kit (715000987) is required to install the LED Light Bar.

Commander, Commander X, Commander XT - 715000976
\$849.99

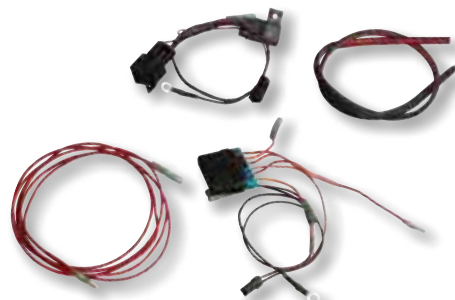

ROOF ACCESSORIES AND LIGHT WIRING KIT

All the necessary hardware, wires, fuses and relay to power your roof lighting for a clean well routed look. Includes additional output for future roof accessories.

Commander, Commander X, Commander XT - 715000987
\$79.99



LIGHT RACK FOR SPORT VISOR

Provides Commander side-by-side vehicle with a custom look. Made of rugged aluminum with a light anodized finish. Essential protection for your accessory lighting systems. Works in conjunction with LED Light Bar, or halogen and/or HID lights separately or in combination without overloading your charging system. Fully integrated. Sport Visor (715000762) is required for installation of the light rack. Lights sold separately.

Commander, Commander X, Commander XT - 715000910
\$149.99



WHEELS

XT 14" WHEELS (SILVER)

Premium cast aluminum rim. Standard on XT models. Sold individually.
 705400632 Front
\$124.99
 705500965 Rear
\$139.99

XT 14" WHEELS (BLACK)

Premium cast aluminum rim with durable black finish. Standard on XT Camo models. Sold individually.
 705400919 Front
\$124.99
 705501261 Rear
\$139.99



PLOW

SUPER DUTY PLOW

Heavy-duty 12 gauge steel blade with integrated reinforcement for maximum durability. Complete plow system with manual lifting and angling. Heavy-duty push tubes withstand the roughest uses. Requires winch for raising and lowering. Easy install. Quick disconnect system for fast installation and removal. Front mount system provides a minimum of 11" of lift. Front mount included.
 715001140
\$999.99

NOTE: Picture shows plow extensions and drift cutters that are not included with the plow.



Front mount



Front mount does not reduce clearance and can be installed with or without front skid plate.



WINCH & HITCH SUPPORT PLATE

Mounting plate for RT40 Warn winch kit (715000658) and front 2" receiver hitch (715000663). Standard on XT models.
715000704
\$89.99



FRONT 2" RECEIVER HITCH

Can be used with a standard 2" draw bar. Complete with integrated quick locking/release pin for easy installation and removal of draw bar. Allows for front-mount pulling/pushing or additional accessory attachments, such as a plow. Winch & hitch support plate (715000704) is required for installation.
715000663
\$89.99



MULTIMOUNT TOW

1.5" bar system, no ball. Requires multimount winch kit (715000659).
715001142
\$44.99



FRONT SWAY BAR

Enhances vehicle performance and control during hard cornering.
715001125
\$479.99



MULTIMOUNT WINCH KIT

For use with RT40 Warn winch kit (715000658). Versatile system that can be easily mounted at the front or rear of the Can-Am Commander side-by-side vehicle. Complete with Can-Am plug-and-play front and rear wire harness. Ergonomic branded handle makes it easy to carry from front to rear. Front 2" receiver hitch (715000663) is required for installation. Integrated receiver allows for use with multimount tow (715001142), not included.
715000659
\$299.99

HITCHES & WINCHES



HITCHES & WINCHES



SYNTHETIC WINCH CABLE

50 feet of 7/32" synthetic cable for RT40 Warn winch kit.
NOTE: Replacing a wire rope with synthetic cable also requires changing the fairlead to avoid damage and wear to the new synthetic cable from the rough surface of the old fairlead.
715001118
\$119.99



SYNTHETIC CABLE EXTENSION

Lightweight 3/4" diameter, easy to handle and won't rattle in cargo box. Easily attaches to winch cable to provide additional 50' of distance. 4,000 lbs single line capacity.
715001120
\$129.99



WIRE ROPE REPLACEMENT

55 feet of 7/32" wire rope for RT40 Warn winch kit.
715001117
\$64.99



ROLLER FAIRLEAD

Heavy-duty replacement fairlead for RT40 Warn winch kit.
715001119
\$119.99



RT40 WARN WINCH KIT

Fully-sealed, capable of 4,000 lbs pulling strength. Includes 1.5hp motor, 55 feet of 7/32" wire rope, ergonomically designed clutch knob, mechanical brake, hand-held remote and integrated dash switch, waterproof contactor and roller fairlead. CE certified.
715000658
\$669.99



WIRELESS REMOTE CONTROL

The system is quick and easy to install, thanks to a wiring harness with an integrated antenna, and all necessary mounting hardware. The system allows you to operate your winch from anywhere within a 50' (15 m) radius, increasing your recovery options. All components are weatherproof.
715000544
\$164.99



MULTI-FIT



TRAILERING AND STORAGE COVER

Can-Am branded 300-denier solution-dyed, water repellent polyester construction. Fits with or without roof, light rack, front rack, light protector, rear bumper, extreme bumper, side mirrors. Has trap for fuel, access to cargo box and passenger area. Heavy duty cord around bottom for secure fit. Features soft material in the windshield area to prevent scratches while traling.

715001025
\$279.99



LOCKABLE GAS CAP

Protects your fuel. Meets latest EPA requirements.

715001124
\$44.99

LOCK FOR TAILGATE

Device locks lower tailgate. Includes key.

715001127
\$29.99



WORK KEY

(Not illustrated)
 Key limits vehicle speed to 25 mph for use on construction sites

715001201
\$44.99



XT SPORT STEERING WHEEL

Polyurethane soft-touch black grip highlighted with silver spokes. Standard on XT and X models.

715001134
\$149.99



REAR WIND SCREEN

Full rear mesh coverage reduces backdraft when windshield is installed. Mounts to roll bar. White Can-Am logo on black mesh.

715001193
\$69.99



ROCK SLIDER

Protects vehicle's sides and undercarriage against large obstacles. Textured black electrocoat for durability. Standard equipment on Commander X model.

Commander, Commander XT - 715001014
\$259.99



2011

PARTS, ACCESSORIES & RIDING GEAR

can-am



STORE.CAN-AM.BRP.COM

IT'S FAST, IT'S CONVENIENT AND IT'S ONLINE NOW!

STORE HOME

CAN-AM HOME

LANGUAGE

MY ACCOUNT

CONTACT US

ONLINE STORES

can-am



CAN-AM ATV & CAN-AM SIDE-BY-SIDE

RIDING GEAR

ACCESSORIES

MAINTENANCE

PARTS



« STORE E-NEWSLETTER »

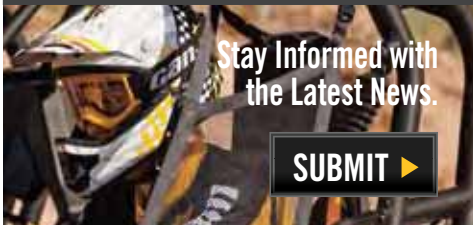

Stay Informed with
the Latest News.

SUBMIT ▶

CHECKING FOR OFF-ROAD VEHICLE ACCESSORIES
& RIDING GEAR... WELCOME HOME!!

Home to the official off-road vehicle on-line store filled with genuine parts, accessories and riding gear brought to you by the same people who built your off-road vehicle. It doesn't get any better!

The exciting new 2011 Can-Am line-up will be available for purchase in September 2010, both **online** and at your **authorized Can-Am dealer!**

**STAY CONNECTED WITH THE LATEST, NEWEST, HOTTEST CAN-AM GEAR:
SIGN UP TODAY FOR OUR PROMO E-NEWS.**



TABLE OF CONTENTS

PARTS & ACCESSORIES

OUTLANDER	4
RENEGADE	12
DS 450	18
DS 250	23
TRACK SYSTEM	24
PLOW ACCESSORIES	27
WINCHES	30
COVERS	32
BAGS	33
MULTI-FIT	34
PRIME TLC FOR YOUR ATV	35
MAINTENANCE	36
DECALS	38
LICENSED PRODUCTS	39
SIZING CHART	40

Read the Side-by-Side vehicle (SSV) and All Terrain Vehicle (ATV) Operator's Guide and watch the Safety DVD before driving. For your safety: wear a helmet, eye protection and other protective gear. In your SSV, fasten lateral net and seat belt at all times. Operator must be at least 16 years old. Users should, however, respect any applicable law establishing a higher minimum age for riding an ATV or SSV. BRP urges you to "TREAD LIGHTLY" on public and private lands. Preserve your future riding opportunities by showing respect for the environment, local laws and the rights of others when you ride. Always ride responsibly and safely. BRP highly recommends that all ATV and SSV drivers take a training course. For safety and training information, see your authorized Can-Am dealer or, in the U.S.A., call the ATV Safety Institute at 1-800-887-2887. In Canada, call the Canadian Safety Council at 1-613-739-1535 ext. 227. ATVs and SSVs can be hazardous to operate. Always remember that riding and alcohol/drugs don't mix. SSVs and ATVs are for off-road use only. Never ride on paved surfaces or public roads. Never engage in stunt driving. Avoid excessive speeds and be particularly careful on difficult terrain. Racing scenes in this brochure were photographed during an organized race involving highly skilled operators under controlled conditions. Do not attempt. Can-Am Outlander MAX ATVs: these ATVs are recommended for drivers aged 16 and older, and passengers aged 12 and older only. Make sure that all laws, regulations, and BRP's warnings/recommendations for ATV and SSV passengers are respected. Never carry passengers on any ATV not specifically designed for such use. Never carry a passenger under the age of 12. A passenger must be able to hold handgrips and to comfortably place both feet flat on the floorboard while seated upright. BRP reserves the right, at any time, to discontinue or change specifications, prices, designs, features, models or equipment without incurring obligation. Some models depicted herein may include optional equipment. Prices are based on Manufacturer Suggested Retail Prices. Dealers may sell for a different price. Taxes are not included. In the U.S.A., products are distributed by BRP US Inc. In Canada, products are distributed by BRP US Inc. In Canada, products are distributed by Bombardier Recreational Products Inc.™ and the BRP logo are trademarks of Bombardier Recreational Products Inc. or its affiliates. UNI is a trademark of UNIFILTER Inc. TWIN AIR is a trademark of Twin Air USA. KYB is a registered trademark of Kayaba. WARN is a trademark of Warn Industries Inc. YUASA is a registered trademark of YUASA Batteries Inc. NGK is a registered trademark of NGK Spark Plugs, Ltd. Smith is a registered trademark of Smith Sport Optics, Inc. Chamude is a registered trademark of Kolon Industries, Inc. Clarino is a trademark of Kuraray Co. Ltd. Teflon HT, Teflon HP and Kevlar are trademarks of E.I. DuPont de Nemours & Co. Lexan is a trademark of General Electric (GE). Primaloft One and Primaloft Cresta are registered trademarks of Albany International Corp. Windows is a trademark of Microsoft group of companies and is used under license from Microsoft. CARLISLE is a trademark of Carlisle Companies. FOX is a trademark of FOX Racing Canada. All other trademarks are the property of their respective owners. © 2010 Bombardier Recreational Products Inc (BRP). All rights reserved. Printed in Canada.

OUTLANDER

- XT FRONT BUMPER KIT ▸ P.6
- REAR TRUNK BOX ▸ P.7
- PASSENGER WIND DEFLECTORS ▸ P.7
- FRONT RACK EXTENSIONS ▸ P.8
- MUDGUARD KIT ▸ P.8
- FRONT SHOCK PROTECTORS ▸ P.15
- FRONT BAG ▸ P.33
- MIRROR ▸ P.34



A-ARM PROTECTORS

Made with high strength aluminum for more protection to the CV joint and rubber boots. Drain hole to release water, mud and debris. Unique design with embossed Outlander name. Easy to install. Sold in pairs.
703500524

\$139.99

FRONT ALUMINUM SKID PLATE

Stamped aluminum. Protection for the front portion of the frame. Use in conjunction with the central chassis skid plate (715000636) for full frame protection.

715000548

\$109.99

CENTRAL CHASSIS SKID PLATE

Protect your frame from the unexpected – a must-have for rugged terrain. Stamped 1/8" (3 mm) aluminum construction. Recessed bolt holes. Cannot be installed with Plow Mounting Kit.

Renegade & Outlander 500, 650, 800 & Outlander MAX

715000636

\$99.99

FOOTWELL PROTECTOR PLATES

Bump up the impact protection to the footwells. 1/8" (3 mm) aluminum construction. Use in conjunction with the central skid plate (703500570 or 715000636). Sold in pairs.

715000547

\$169.99

TRAILING ARM PROTECTORS

1/8" (3 mm) aluminum construction. Replace stock plastic protectors. Sold in pairs.

Renegade & Outlander - 715000311

\$139.99

REAR DIFFERENTIAL PROTECTOR

1/8" (3 mm) aluminum construction. Replaces stock plastic protector.

Renegade & Outlander - 715000285

\$129.99

REAR SKID PLATE

1/8" (3 mm) aluminum plate provides additional protection for your frame. A must when riding on extremely rugged terrain.

Renegade & Outlander 500, 650, 800 - 715000609

\$59.99

Outlander MAX 500, 650, 800 - 715000610

\$74.99

Must be installed with the Central and Front Skid Plate (703500570). Outlander MAX 400 only - 703500381

\$79.99

Outlander 400 only - 703500382

\$64.99



CENTRAL AND FRONT SKID PLATE

Two-piece 3/16" (5 mm) aluminum full-body skid plate designed to protect frame and engine case from rough terrain conditions.

Outlander 400 only - 703500570

\$104.99



LOWER BUMPER EXTENSION

Adds protection to lower front plastic fascia. Easy to install. No drilling required. Removable for Apache Track Kit installation. Must be installed with XT Front Bumper Kit (715000670).
715000635 Black
\$79.99



XT REAR BUMPER KIT

Adds on to stock bumper to convert your Outlander into an XT model. Large tube construction with textured black finish.
2009 800R only & 2010-2011 - 715000671 Black
\$144.99
2006-2009, except 800R - 703500550 Black
\$149.99
2004-2005 - 703500349 Black
\$159.99



XT FRONT BUMPER KIT

Adds on to stock bumper to convert your Outlander into an XT model. Large tube construction with textured black finish.
2009 800R only & 2010-2011 - 715000670 Black
2006-2009, except 800R - 703500551 Black
\$159.99
2004-2005 - 703500348 Black
\$169.99



REAR CARGO BOX

Convert your Outlander MAX into a very versatile vehicle in only 30 seconds. Designed exclusively for the Outlander MAX, this latest-generation rear cargo box is built tough and made of high-resistance polyethylene plastic. Featuring a removable rear tailgate that also conveniently installs in the center of the box. Since it can handle a maximum payload of 260 lbs (118 kg), you'll really hit paydirt with this cargo box. Dimensions: 35" (88 cm) W X 21" (54 cm) D X 7" (17 cm) H.
Outlander MAX 2006-2011 - 715000734 Black
\$439.99



FOOTPEG KIT

Made of aluminum, the Footpeg Kit provides maximum integrated grip. Larger than stock model, it gives more stability during vigorous riding. Kick-up end generates added grip during hard cornering.
715000916
\$34.99



FOOTPEG EXTENSIONS

Made of aluminum, the Footpeg Extensions provide grip in all weather and riding conditions. Use in conjunction with footpeg kit (715000916). Sold in pairs.
715000996
\$69.99





HIGH WINDSHIELD KIT

These top of the line Windshield Kits provide excellent wind protection. Can be used on standard, XT and LTD models. Easy to install and remove. Can-Am branded.

Outlander 500, 650 & 800
 715001015 Yellow
 715001016 Red
 715001017 Tinted Black
\$189.99



ULTRA HIGH WINDSHIELD KIT

Provides superior wind protection. 4" (10 cm) higher windshield. Added substructure to control vibration. Can-Am branded and color matched. Can be used on standard, XT and LTD models. Easy to install and remove.

Outlander 500, 650 & 800
 715001018 Yellow
 715001019 Red
 715001020 Tinted Black
\$219.99



WINDSHIELD KIT

Can be used with or without handlebar protectors. Includes steering cover. Easy to install and remove.

Outlander 400 - 703500444
\$154.99



PASSENGER HEATED GRIPS

Heat control can be set to High or Low. Ideal for replacing stock passenger handles. Added passenger comfort. Easily removable when summer comes. Easy to install.

Outlander MAX 2006-2011 - 715000634
\$159.99



REAR TRUNK BOX

Perfect fit with vehicle. Made of impact resistant polyethylene. Fully sealed lid. Tray quick-hooks to box. Equipped with lid key lock. The molded handle makes lifting and moving the box easy. Robust double wall lid. Improved trunk latch and attachment system on rack. Easy-install quick attach system (715000273) available as an option. Fits any ATV on the market. Cannot be used with Rear Rack Extensions (703500537 & 703500538).

2006-2011 - 715000626 Black
\$279.99

QUICK ATTACH/DETACH SYSTEM FOR REAR TRUNK BOX

(Not illustrated)

2006-2011 - 715000273
\$79.99



PASSENGER WIND DEFLECTORS

These wind deflectors fit snugly around the passenger handles and provide total comfort while riding. Easy to install and remove.

Outlander MAX 2006-2011 - 715000233
Outlander MAX 2004-2005 - 715000231

\$59.99





MUDGUARD KIT

Offers more protection from dirt and debris. Extra flair for that ruggedly cool look. Kit includes front and rear extensions and all mounting hardware.

Outlander 500, 650, 800 - 715000533 Black
 Outlander 400 2006-2011 - 715000297 Black
 Outlander 400 2004-2005 - 715000296 Black
\$129.99



FENDER PROTECTORS

Provide extra fender protection when you're in tight situations. 1" (25 mm) diameter steel construction with textured black finish.

Outlander 2006-2011 - 703500544 Black
 Outlander MAX 2006-2011 - 703500546 Black
\$109.99



FRONT RACK EXTENSIONS

Offers 4" (100 mm) or 7" (178 mm) of clearance with the existing racks. Secure bulky loads with its sturdy tube construction. Textured black finish.

Medium Profile 4" (100 mm) (Not illustrated) 2006-2011 - 703500536 Black \$89.99	High Profile 7" (178 mm) 2006-2011 - 703500535 Black \$89.99
--	---



REAR RACK EXTENSIONS

Offers 4" (100 mm) or 7" (178 mm) of clearance with the existing racks. Secure bulky loads with its sturdy tube construction. Textured black finish.

Medium Profile 4" (100 mm) (Not illustrated) 2006-2011 - 703500538 Black \$89.99	High Profile 7" (178 mm) 2006-2011 - 703500537 Black \$109.99
--	--



FRONT HITCH

Front hitch for Outlander with or without a winch. This hitch offers 750 lbs (340 kg) of towing capacity. Needs to be installed with the winch fairlead bracket (715000696) for all Outlander models equipped with a winch.

2006-2011 - 703500421 Black
\$79.99



FRONT HPG SHOCK KIT

High pressure gas (HPG) shocks. Provides enhanced Outlander ride, handling and control. Razor sharp calibration for even the most demanding riders. Fade-free performance. Sold in pairs.
 Outlander 650, 800 Standard models - 715000303
\$221.99



FRONT HPG SHOCK KIT WITH SPRINGS

Outlander 650, 800 XT models - 715000304
\$259.99

REAR HPG SHOCK KIT WITH SPRINGS

(Not illustrated)
 Outlander 650, 800 Standard and XT models - 715000305
\$259.99



FRONT SPRING KIT

Front heavy-duty springs. Stiffer than factory installed front springs for more precise front suspension behavior. Ideal for snow plowing or heavy load transportation applications. Sold in pairs.
 Outlander 650, 800 Standard and XT models - 715000306
\$74.99



XT HANDLEBAR PROTECTOR KIT

Add handlebar protection with our XT-style kit.
 Outlander 500, 650, 800 - 703500553 Black **\$59.99**
 Outlander 400 2005-2011 - 715000271 Black
 Outlander 400 2004 - 715000272 Grey **\$99.99**



NEW GPS PROTECTOR

Provides extra protection from mud and dust. Covers GPS support when GPS is removed.
 Outlander LTD 2010-2011
 715001210 - Black
\$19.99



715000961

GPS ADAPTOR FOR OUTLANDER LTD WINDSHIELD

Kit needed to install your GPS from LTD model when using a Can-Am windshield.
 Outlander 2009 and prior - 715000309
 Outlander LTD 2010-2011 - 715000961
\$24.99



NEW SNORKEL KIT

The only way to tackle extreme muddy conditions. Snorkel kit comes complete with redesigned air-box with extended air intake and a new extended CVT exhaust outlet conveniently integrated into the upper gauge pod, maximizing muddy condition performance. Standard equipment on X mr model.

Outlander 650 & 800R 2010-2011
715001136
\$259.99



NEW OUTLANDER X XC FRONT PRE-RUNNER BUMPER

Lightweight yet sturdy aluminum bumper provides maximum frontal protection. Incorporated front skid plate, reinforced tubing and still works with a winch.

Outlander 800R 2009 & Outlander 2010-2011
715001123 Aluminum
\$269.49



NEW RADIATOR RELOCATOR KIT

Relocates radiator to top mount position to prevent mud packing. For use in extreme muddy conditions, providing maximum performance. Includes all brackets, hardware and hoses (radiator not included).

Outlander 650 & 800R 2010-2011
715001178 Black
\$249.99



NEW X MR TRACTION PLATES

Provide extra foot grip for driver when riding in extreme muddy conditions. Help driver maintain ideal riding position to maximize vehicle traction. Not meant for a passenger.

Outlander Max
715001137 Aluminum
\$149.99



NEW OUTLANDER X XC WINCH MOUNTING KIT

Required for winch installation on models equipped with the X xc bumper. Must be used in conjunction with winch mounting kit (703500547) and roller fairlead (715000011) (Winch not included)

Outlander X xc 2011
(or **Outlander with X xc bumper**)
715001121 Black
\$39.99



RECEIVER HITCH

Powder-coated finish. Does not affect ground clearance. Trailer ball not included. Rear hitch plate (715000286) is required for Renegade and Outlander X xc 2011.

Renegade & Outlander with hitch plate kit -
715000325
\$97.99





GUN-BOOT

The best way to transport your rifle or shotgun. This high-impact case securely holds your rifle while providing a padded dust-proof and water-resistant protection.
Outlander & Rally - 715000028 Black
\$69.99

GUN-BOOT SUPPORT

(Not illustrated)
 Used in conjunction with the gun-boot. Attaches to the rear rack.
Outlander & Rally - 715000029 Black
\$89.99



NONSKID LUGGAGE RACK STRIPS

Rubber strips you can apply to your front and rear luggage racks to maintain your cargo in position. Helps keep your luggage rack scratch free. Easy to install. Sold in packs of 4.
Outlander 2006-2011 - 703500569 Black
\$15.99



RADIATOR PROTECTOR

Metal shield which mounts over radiator face providing protection from stones and branches.
Outlander 2006-2011 - 703500543 Black
Outlander & Rally 2004-2005 - 703500427 Black
\$59.99



FLASHER AND HORN KIT

Complete flasher and horn kit. Integrates to vehicle. Easy to install. Not for road use.
Outlander 800R 2009-2011 - 715000695
\$249.99



REWIND STARTER KIT

Complete manual rewind assembly.
Outlander 400 EFI 2010-2011 - 715001034
\$154.99

RENEGADE

- CENTER CONSOLE DAY LIGHT ▶ P.14
- REAR ALUMINUM RACK ▶ P.14
- FRONT SHOCK PROTECTORS ▶ P.15
- HANDLEBAR WIND DEFLECTORS ▶ P.17
- FULL WRAP ALUMINUM MOUNTING KIT ▶ P.17
- MIRRORS ▶ P.34



A-ARM PROTECTORS

Add protection to your Renegade lower A-arm with this high-strength aluminum protector with drain hole to release water, mud and debris. 1/8" (3 mm) aluminum construction. Easy to install. Replaces stock plastic protectors. Engraved Can-Am logo. Sold in pairs.

715000287
\$139.99

CENTRAL CHASSIS SKID PLATE

Protect your frame from the unexpected – a must-have for rugged terrain. Stamped 1/8" (3 mm) aluminum construction. Recessed bolt holes. Cannot be installed with Plow Mounting Kit.

Renegade & Outlander 500, 650, 800 & Outlander MAX
 715000636
\$99.99

FOOTWELL PROTECTOR PLATES

Bump up the impact protection to the footwells and structure. 1/8" (3 mm) aluminum construction. Use in conjunction with a central chassis skid plate (715000636). Sold in pairs.

715000686
\$169.99

REAR DIFFERENTIAL PROTECTOR

1/8" (3 mm) aluminum construction. Replaces stock plastic protector.

Renegade & Outlander - 715000285
\$129.99

TRAILING ARM PROTECTORS

1/8" (3 mm) aluminum construction. Replace stock plastic protectors. Sold in pairs.

Renegade & Outlander - 715000311
\$139.99

REAR SKID PLATE

1/8" (3 mm) aluminum plate provides additional protection for your frame. A must when riding on extremely rugged terrain.

Renegade & Outlander 500, 650, 800 - 715000609
\$59.99





NEW MUD GUARD KIT FOR RENEGADE

Integrated extended fender flairs for sporty look and full body protection from dirt and water. Kit of 4 includes front and rear extensions and all mounting hardware.

Renegade 2007 to 2011

715001115 Black

\$189.99



X PACKAGE REAR SHOCK & SPRING KIT

Rebound and dual speed compression adjustable gas shocks. Kit includes matching springs and hardware. Sold in pairs.

2008-2011 - 715000538

\$979.99



X PACKAGE FRONT SHOCK & SPRING KIT

Rebound and dual speed compression adjustable gas shocks. Kit includes matching springs and hardware. Sold in pairs.

715000536

\$614.99



FRONT SWAY BAR KIT

Enhances vehicle stability and control during hard cornering.

Renegade 2010-2011 - 715000967

\$149.99



REAR ALUMINUM RACK

30 lbs (14 kg) capacity. Compact, lightweight aluminum construction. Engraved Can-Am logo. Stamped 5052 aluminum center plate. Easy to install.

715000242

\$164.99



CENTER CONSOLE DAY LIGHT

Mountable on top end of center console. Enhance look of vehicle.

715000691

\$69.99



REAR HITCH PLATE

Includes bolt-on hitch plate and hardware.

Renegade & Outlander X xc 2011 - 715000286

\$39.99





UNI+ FOAM FILTER

Ease of maintenance. Can be easily washed, re-oiled and re-used when subject to severe dusty/muddy environments. Contains a rigid adaptor with an added flair providing retention of the air filter.

Outlander 500, 650, 800 & Renegade 2010-2011 and prior, except 800R and 650 2010-2011 - 715000310
\$30.99



NEW CAN-AM FOAM AIR FILTER BY TWINAIR+

Maximizes performance by increasing air flow throughout RPM range. Maintenance-friendly, i.e. just wash, re-oil and re-use after riding in severely dusty/muddy environments.

Renegade & Outlander 800R 2009-2011 and 650 2010 & 2011 - 715001130
\$69.99



CVT AIR INTAKE

Designed to relocate and maximize height of the CVT air intake to prevent belt slippage in deep snow or muddy conditions. Equipped with integrated CVT pre-filter to also reduce dust and extend CVT and belt life.

Renegade 500, 800 2007-2009 - 715000984
Outlander 500, 650, 800 2008-2009 - 715000970
\$64.49



AIR PRE-FILTER

Filters out even the tiniest of contaminants in dusty conditions. Extends service period. Use in conjunction with stock filter. Air filter not included.

DS 450 & Outlander 400 - 707800293
\$20.99



AIR PRE-FILTER

Adds extra protection to your engine in harsh riding conditions. Filter blocks particles larger than 0.005". Note: A pre-filter is necessary to maintain the vehicle warranty when an Apache Track kit is installed.

Renegade & Outlander 500, 650 & 800 2008 and prior, 500, 650 2009 and 500 2010 - 715000291
\$24.99

AIR BOX PRE-FILTER

(Not illustrated)
 Add extra protection to your engine in harsh riding conditions. Filter blocks particles larger than 0.005". Note: A pre-filter is necessary to maintain the vehicle warranty when an Apache Track kit is installed.

Renegade & Outlander 650 2010-2011, 800R 2009-2011
715000908
\$36.49



HEATED HAND GRIP KIT

Keep your hands warm while riding with this easy-to-install hand grip kit. Includes a 3-position switch, switch cover, wiring harness, hand grip and handlebar end cap. Grips are 4 7/8" (12 cm) long with an interior diameter of 7/8" (22 mm). Grip heat control can be set to High (20 watts) or Low (10 watts).

Renegade & Outlander - 715000322
\$79.99



HEATED THROTTLE LEVER ASSEMBLY

Improved heating element provides faster warm-up time and increased maximum temperature. For a perfect fit and finish, designed especially for your Can-Am ATV. Kit includes a 3-position switch, switch cover, wiring harness and throttle lever assembly.

Renegade & Outlander - 715000584
\$61.99



SHIFTER LOCK

Locking device locks transmission shifter in "Park" position. Minimum 5000 key combination. Fully integrated.

Renegade & Outlander 500, 650, 800 2009-2011 - 715000689
Outlander 400 - 715000690
\$49.99



NEW SHOCK PROTECTOR

Provides X-package shock rods with additional protection against pitting.

Fit X-package KYB shocks except DS 450 X xc
715001209 Black
\$29.99



FRONT SHOCK PROTECTORS

Feature ventilation holes. Sold in pairs.

Renegade & Outlander - 715500301
\$29.99



NEW LOCKABLE GAS TANK CAP

Protects your fuel. Meets latest EPA requirements.

Renegade & Outlander - 860200387 Black
\$39.99



XT RIM

Made of aluminum. Upgrade for non XT models.
Renegade & Outlander, except Outlander 800 2006
 Front - 705400648 Rear - 705500986
\$119.99 \$129.99



XT-P RIM

Made of aluminum. Upgrade for non XT models.
Renegade & Outlander, except Outlander 800 2006
 Front - 705400687 Rear - 705501019
\$124.99 \$139.99



LTD RIM

Made of aluminum. Upgrade for non XT models.
Renegade & Outlander, except Outlander 800 2006
 Front - 705400683 Rear - 705501015
\$124.99 \$139.99

NOTE: MATCHING NUTS - 250100100 Black and 250100082 Chrome — MATCHING CAP - 705400680 Black



XTR CUSTOM WHEEL KIT

Custom Can-Am XTR branded 12" (30.5 cm) painted aluminum rims. Includes matching chrome nuts and center covers. Set of 4.
Renegade & Outlander, except Outlander 800 2006 - 715000611 Black - 715000612 Yellow
\$499.99



RENEGADE RIM

Center cast aluminum rims.
Renegade & Outlander, except Outlander 800 2006
 Front 705400506 Rear 705500837
\$119.99 \$129.99



COLORED FINS FOR RIMS

Plastic fins that enhance appearance of your vehicle. Pack of 8.
Fits on following wheels: XT, XT-P and LTD 2010-2011 (705500986, 705501015, 705501019, 705400687, 705400648, 705400683)
 705400681 Yellow
 705400950 Steel Grey (Not illustrated)
\$13.04



BEAD LOCK

Cast aluminum. Must be installed on rims 705400794 and 705501137.
Renegade & Outlander 650 and 800, except 800 2006 - 705400841
\$79.99



RENEGADE X RIM

Center cast aluminum rims. Welded exterior and interior reinforcement rings. Needs to be installed with Bead Lock (705400841).
Renegade & Outlander 650 and 800, except 800 2006
 Front - 705400794 Rear - 705501137
\$124.99 \$139.99



FULL WRAP ALUMINUM MOUNTING KIT

Lightweight black die cast aluminum construction. Includes complete hardware. Handlebar wind deflectors sold separately.
Renegade, Outlander 500, 650, 800 & DS 450 - 715000545
\$79.99



SHORT ALUMINUM MOUNTING KIT

Lightweight black die cast aluminum construction. Includes complete hardware. Handlebar wind deflectors sold separately.
Renegade, Outlander 500, 650, 800 & DS 450 - 715000513
\$49.99



HANDLEBAR WIND DEFLECTORS

Rugged injected plastic construction with Can-Am logo. Includes removable cap for air flow adjustment. Mounting kit sold separately.
Renegade, Outlander 500, 650, 800 & DS 450
715000733 Yellow / Black (Not illustrated)
\$44.99
 715000537 White / Black
 715000525 Black / Yellow
\$49.99



MIRROR KIT FOR HANDLEBAR WIND DEFLECTORS

Handlebar wind deflector mount design. To be used with handlebar wind deflectors. Sold in pairs.
Renegade, Outlander 500, 650, 800 & DS 450 - 860200080
\$24.99



ALUMINUM TAPERED HANDLEBAR

7/8"- 1 1/8" (22 mm - 28 mm) tapered handlebar made of 6061-T6 aluminum. Includes all hardware, center steering foam and cover.
Renegade & Outlander 500, 650, 800 - 715000550
\$99.99

DS 450

X PACKAGE CHASSIS SKID PLATE ▶ P.19

X PACKAGE NERF BARS ▶ P.19

REAR ALUMINUM BASKETS ▶ P.19

FRONT SHOCK PROTECTORS ▶ P.21

NUMBER PLATE ▶ P.21

X PACKAGE FRONT
ALUMINUM BUMPER ▶ P.21

X PACKAGE ADJUSTABLE
FRONT SHOCKS ▶ P.21

SPEEDOMETER ▶ P.22



A-ARM PROTECTORS

Lightweight injected plastic A-arm protectors provide strong protection for lower aluminum A-arm. Can-Am branding visible from top and underneath vehicle. Easy installation, no holes to drill. Sold in pairs. Does not fit DS 450 X mx.

715000517 **Black**
715000589 **Yellow**
\$69.99

X PACKAGE CHASSIS SKID PLATE

Lightweight and strong full chassis skid plate. 5052 $\frac{1}{8}$ " (3 mm) stamped aluminum construction. Recessed bolt holes. Includes all necessary hardware.

715000506
\$124.99

FRONT FENDER EXTENSIONS

Lightweight aluminum extension connects the front fender to the nerf bar. Sold in pairs.

715000514
\$74.99

X PACKAGE NERF BARS

Strong lightweight rectangular aluminum tubing provides extra protection for assertive riding. Complete with mounting hardware and black webbing. Must be installed with Rear Aluminum Baskets (715000673). Sold in pairs.

2009 - 715000672
\$199.99

2008 and prior - 715000505
\$209.99

REAR ALUMINUM BASKETS

For direct replacement of stock plastic version. $\frac{1}{8}$ " (3 mm) 5052 aircraft aluminum construction and $\frac{7}{8}$ " (22 mm) tubing. Stronger construction than stock model. Must be installed with X Package Nerf Bars (715000672).

X Package 2009 - 715000673
\$259.99

Can be installed with
or without X Package Nerf Bars (715000505).

715000526
\$264.99

X PACKAGE SWING ARM SKID PLATE

Lightweight protection for your swing arm, rear disc, sprocket and chain. 5052 $\frac{3}{16}$ " (5 mm) aluminum construction. Replaces stock plastic protector.

715000507
\$124.99

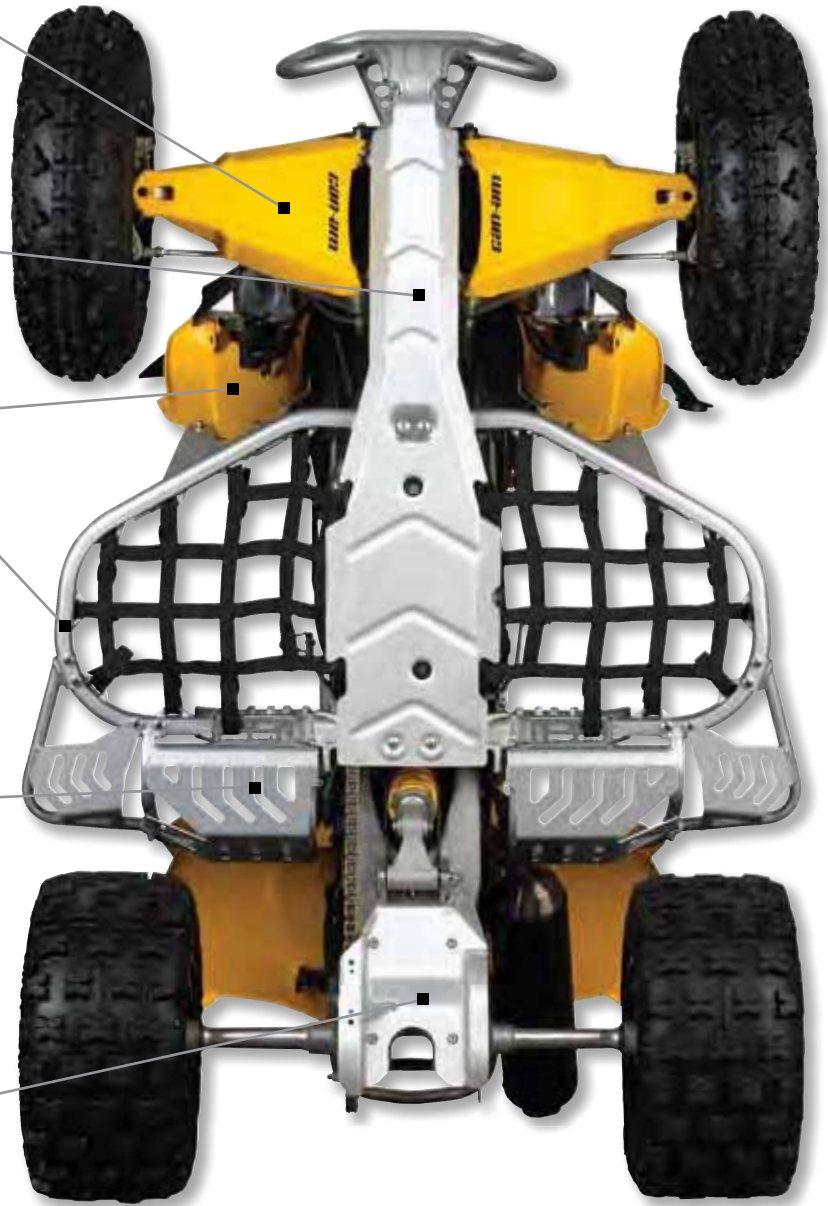



X XC FRONT RIM KIT

Dimensions: 10" x 5" (25 cm x 13 cm) diameter.
ITP[®] T-9 Trac-Lock[†] rims. Sold in pairs.
715000902
\$459.99



X XC REAR RIM KIT

Dimensions: 9" x 8" (23 cm x 20 cm) diameter.
ITP T-9 Trac-Lock rims. Sold in pairs.
715000905
\$474.99



X MX FRONT RIM KIT

Dimensions: 10" x 5" (25 cm x 13 cm) diameter.
ITP T-9 GP rims. Sold in pairs.
715000903
\$219.99



X MX REAR RIM KIT

Dimensions: 8" x 8" (20 cm x 20 cm) diameter.
ITP T-9 Trac-Lock rims with bead lock and inside reinforcement. Sold in pairs.
715000906
\$399.99



X PACKAGE REINFORCED RIM KIT

Black painted aluminum rims with exterior reinforcement ring. Sold in sets of 4. Tires not included. Always respect tire size appropriate for your vehicle. Bead lock with inside reinforcement.
715000510
\$374.99



X PACKAGE ADJUSTABLE FRONT SHOCKS

Ultra-high performance KYB® fully adjustable shock. Includes rebound and high/low speed compression adjustments. More performance oriented valving than stock vehicle. Uses original stock spring. Sold in pairs. 715000511
\$569.49



X PACKAGE FRONT ALUMINUM BUMPER

Extra-large and lightweight front bumper offers the best protection for all forms of racing. 6063 aluminum construction. Provides superior coverage to the front of your DS 450. Required to install number plate. 715000508
\$109.99



FRONT SHOCK PROTECTORS

Offer added protection against tough terrain and weather conditions. Sold in pairs. 715500302
\$34.99



NUMBER PLATE

Injection molded high gloss finish. To be used with X Package front aluminum bumper (715000508). 715000521 **Black**
 715000522 **Yellow**
\$21.99



FRONT SPROCKETS

Hardened steel construction. Changing sprocket ratio will vary vehicle top speed and behaviour. Includes snap ring. For racing applications only.

- 13-tooth (-1) - 715000519
- 14-tooth (stock) - 715000591
- 15-tooth (+1) - 715000518

\$24.99



REAR SPROCKETS

Lightweight 7075 T-6 aluminum construction. Changing sprocket ratio will vary vehicle top speed and behaviour. For racing applications only.

- 39-tooth (-3) - 715000527
- 42-tooth (stock) - 715000592
- 44-tooth (+2) - 715000515

\$74.99

\$79.99



SPEEDOMETER

Digital speedometer. Complete kit with mounting pod. Includes reliable speed sensor built into transmission and extra race functions, e.g. maximum speed, average speed, lap counter, comparative average vs. actual speed and RPM. Easy to install.

2009-2011 - 715000512

\$249.99



REGINA Z-RING CHAIN

This chain is the best choice for the most severe and demanding applications. Among other characteristics, the ZR chains feature high alloy steel plates and pins, solid bushings and rollers, shot-peening of plates, pins and rollers, performance-enhancing pre-stretched and "Can-Am yellow" outer plates. Stronger than stock chain (32000N). 102 link to match with different sprocket sizes. Includes connecting link.

715000523

\$109.99



FRONT PLASTIC GRILLE

Add color to your vehicle.

2009 and prior - 715000516

\$16.99

DS 250

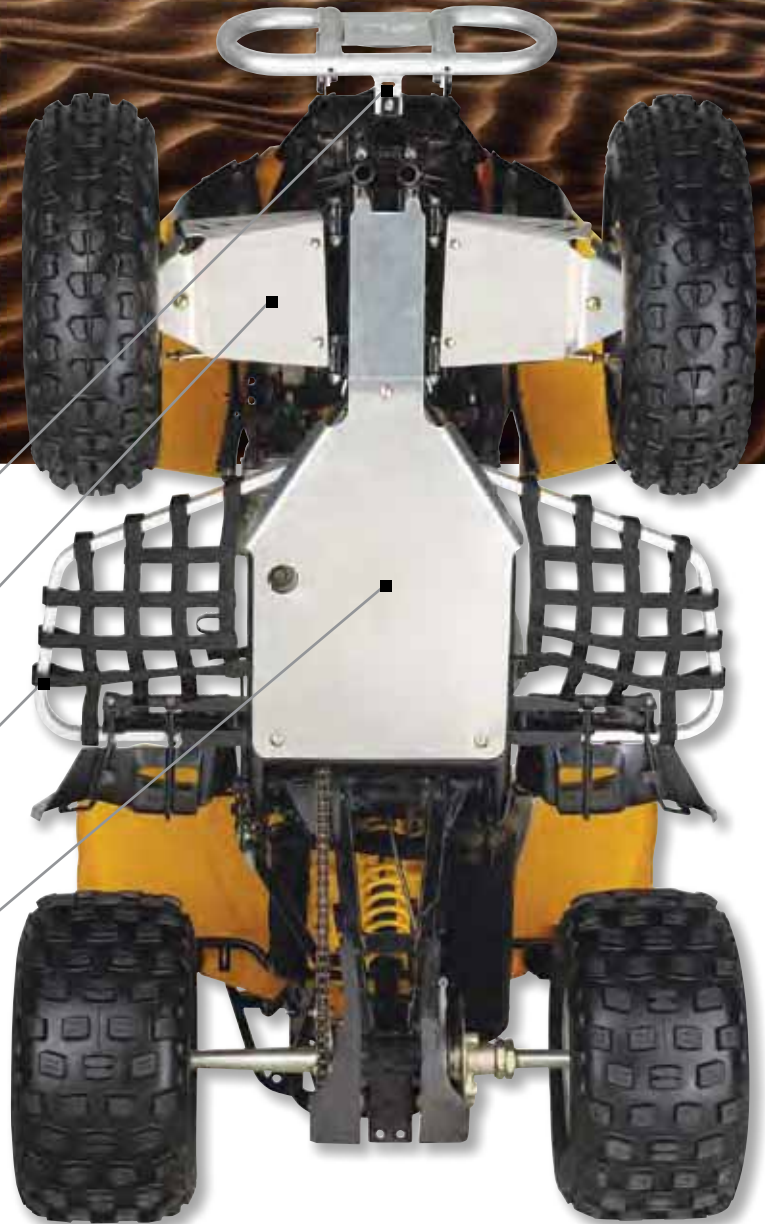

FRONT BUMPER BRACKET

Adds extra protection to the front of your vehicle.

715000241

\$69.99

A-ARM PROTECTORS

These aluminum parts provide maximum A-arm protection.

703500618

\$124.99

NERF BARS

Strong lightweight rectangular aluminum tubing provides extra protection for hard riding. Complete with mounting hardware and black webbing. Sold in pairs.

703500617

\$249.99

FULL-BODY SKID PLATE

Aluminum full chassis skid plate designed to protect your frame and engine case from rocks and undercarriage damage. Maximum underbody protection when driving your DS on the most rugged terrain.

703500616

\$159.99



MIRROR

Stem includes 5/16" (8 mm) thread.

Right - S88110RA1000

Left - S88120RA1000

\$20.99



REAR RACK

Sturdy steel construction, powder paint finish. Can be used with rear rack bag (715000264).

715000243 Black

\$224.99



REAR RACK BAG

100% water-repellent polyester bag. Specially designed to fit on the rear rack (715000243).

715000264 Black

\$89.99



APACHE WT SYSTEMS

THE WIDEST TRACK IN THE INDUSTRY

The 13^{5/8}" x 1" (34.6 cm x 2.5 cm) rear track profile provides a larger footprint and industry-leading flotation and a 11^{1/2}" (29 cm) arc-shaped front track reduces vibration and steering effort.

NOW INCLUDED WITH THE NEW APACHE WT SYSTEMS

REAR AND FRONT MOUNTING KITS

A simplified system that reduces installation time. New and improved front mounting kit allows for smoother steering with less effort and reduced stress on the front suspension.

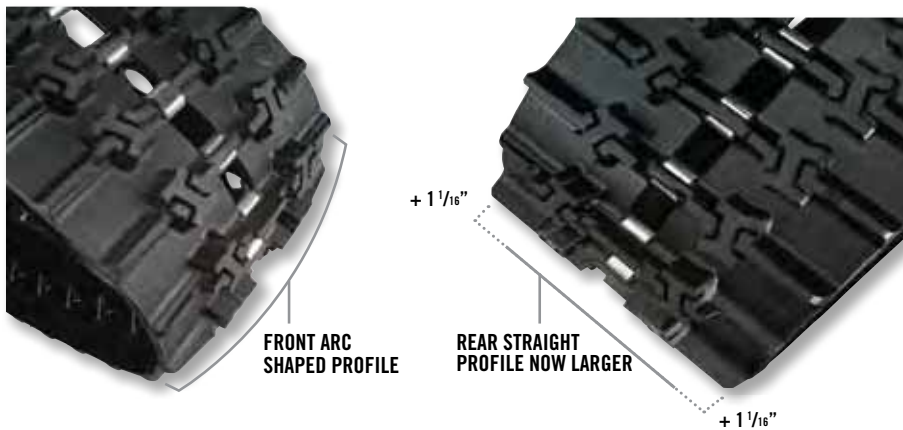

APACHE WIDE TRACK SYSTEM

(Not illustrated)
Same great features that have made this a must-have and more. Specially designed for your Can-Am ATV.
Outlander & Outlander MAX - 715001086
\$3,399.99

STUDED APACHE WIDE TRACK SYSTEM

Additional traction providing more control in icy conditions. Factory pre-studded tracks. 114 studs per rear track. 76 studs per front track. 380 studs total.
Outlander & Outlander MAX - 715001087
\$3,659.99

Note: The Apache WT System is the only track kit available that maintains the Can-Am ATV vehicle warranty.



CVT PRE-FILTER

Designed to prevent snow intrusion in the CVT and belt slippage when Apache Track System is used in deep snow. Easy to install and remove. Comes standard on Renegade and Outlander 800 2009.
Renegade & Outlander 500, 650, 800, 2009 and prior - 715000552
\$6.49



CVT AIR INTAKE

Designed to relocate and maximize height of the CVT air intake to prevent belt slippage in deep snow or muddy conditions. Equipped with integrated CVT pre-filter to also reduce dust and extend CVT and belt life.
Outlander 500, 650, 800 2008-2009 - 715000970
\$64.49

PRE-FILTERS

See P.15
Add extra protection to your engine in harsh riding conditions. Filter blocks particles larger than 0.005".
715000908 - Air Box Pre-Filter
715000291 - Air Pre-Filter
Note: A pre-filter is necessary to maintain the vehicle warranty when an Apache System is installed.

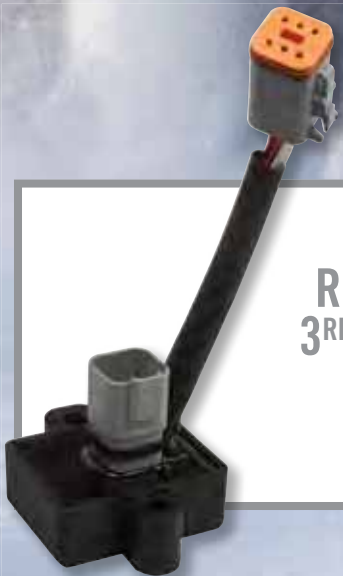

**INDUSTRY
REVOLUTION:
3RD DPS MODE**

**ONLY AVAILABLE WITH
THE APACHE WT SYSTEMS**

The 3rd DPS mode, when installed with the Apache WT system, optimizes power steering performance. It is a module for the Dynamic Power Steering maximizing steering agility at lower speeds while providing firmer steering at cruising speeds. In addition, it provides a speed correction factor for the speedometer.

BUILD YOUR PLOW SYSTEM IN 3 EASY STEPS BY SELECTING:

1 THE PUSH FRAME & OPTIONAL FEATURES

Super-duty push tubes withstand the roughest use. Mid-mount carriage provides up to 11½" (29 cm) of lift. Push frame fits all blade styles.



PUSH FRAME

Quick-attach not included.
715001064 Black
\$239.99

PUSH FRAME FEATURES

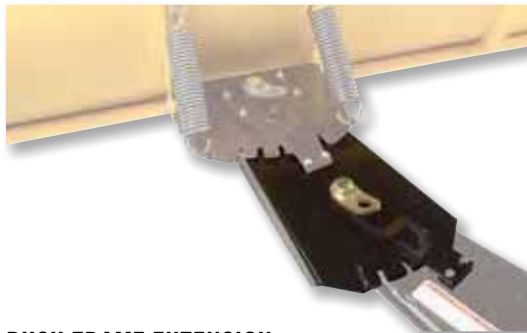

PUSH FRAME EXTENSION

12 ¼" (31 cm) chassis extension for use with Apache Track systems. Increases angle and enables extra blade rotation. Cannot be used with Manual EZ Lift System (703500522) and Remote Angling System (715000260).
703500603
\$119.99

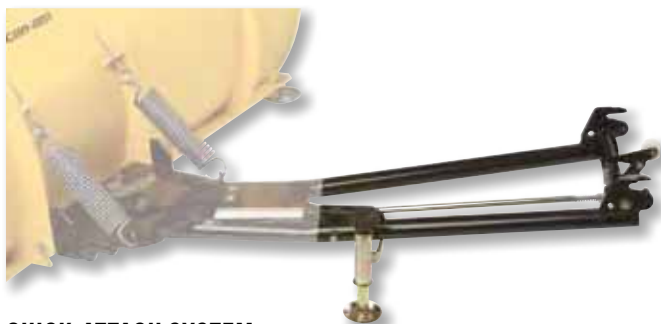

QUICK-ATTACH SYSTEM

Available as an option to upgrade base Push Frame. The plow will be easy to install with this quick-attach system. Durable with a powder-coated rust-resistant finish.
715000731
\$129.99



REMOTE ANGLING SYSTEM

Increases operator convenience. Swivel system allows the driver to manually pivot the plow blade from the driver's seat. Cannot be used with the Push Frame Extension (703500603).
715000260
\$169.99

2 THE PLOW

Straight or One Way State



STRAIGHT PLOW

Super-duty plow blades made from 12-gauge steel. Replaceable wear blades. When angled, 60" (1.5 m) blade clears 53½" (1.36 m) path, 54" (1.37 m) blade clears 48" (1.23 m) path. Blades swivel left or right, 5 positions. Large pin designed for easy blade rotation to eliminate dirt and snow buildup at pivot point. Blade design provides best snow/dirt roll-off at any angle. Yellow-colored version Can-Am branded.

54" (1.37 m)

- 715000647 **Yellow**

- 715000208 **Black**

\$184.99

60" (1.5 m)

- 715000648 **Yellow**

- 715000209 **Black**

\$189.99



ONE WAY STATE PLOW

One-way "winged" state plow designed to throw snow higher. Wing end measures 25" (63 cm) high and plow tapers down to 16" (41 cm). Rubber flap designed to keep snow away from driver. Yellow-colored version Can-Am branded.

60" (1.5 m)

- 715000649 **Yellow**

- 715000207 **Black**

\$299.99

66" (1.68 m)

- 715000650 **Yellow**

- 715000253 **Black**

\$339.99

3 THE MOUNTING SYSTEM FOR YOUR VEHICLE

Quick release pins attach and detach plow blade and base assembly in minutes. Can be used with or without Quick Attach System (715000731). Simplified installation. No frame drilling required.



(Not illustrated)
Renegade 2010-2011
& Outlander X xc 2011 - 715001206
\$134.99

Outlander 2006-2011
& Renegade 2007-2009 - 715001205
\$104.99

(Not illustrated)
Outlander 400 2004-2005 - 715000586
\$79.99

Traxter & Quest - 715000258
\$79.99

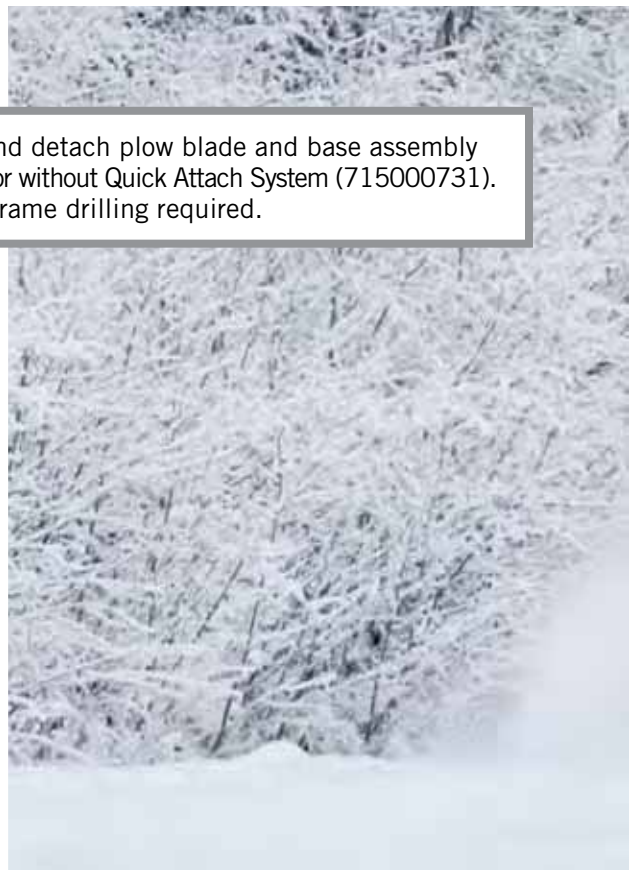



REAR TIRE CHAIN

Improve your traction in mud and snow. Sold in pairs.
 25 X 10 X 12 - 715000225
 26 X 10 X 12 - 715500218
\$79.99



PLOW LIGHTS

Featuring 35W H3 halogen bulbs and a lens design that achieves 110-degree beam spread to provide excellent lighting for plowing.
 Outlander - 715000063
\$69.49



PULLEY KIT

Pulley kit to be used in conjunction with the winch when using a snow plow. Recommended to increase winch efficiency. To be used with the XT Front Bumper.
 715000279
\$44.99



DRIFT CUTTER

Helps keep snow in the plow. Designed with a rear pivot point. Works with both Straight and One Way State blades.
 Left: - 715000217
 Right: - 715000218
\$79.99



SYNTHETIC WINCH CABLE FOR PLOW

Specially designed for plowing applications. 8' (2.4 m) section of durable, extra-strong synthetic rope. Stands up to repeated, sharp angle pulls used to lift heavy plow blades. Temporarily replace your winch rope for plow season to save wear and tear on wire rope.
 715000540
\$39.99



RT25 WARN[†] WINCH KIT

Fully-sealed Warn winch with 2,500 lbs (1,134 kg) of pulling strength. Includes a 0.9hp motor, 50' (15 m) of $\frac{3}{16}$ " (5 mm) wire rope, an ergonomically designed clutch knob, mechanical brake, sealed mini-rocker handlebar switch, a waterproof contactor and a roller fairlead. CE certified.

715000553

\$424.99



XT15 WARN WINCH KIT

Lightweight Warn 1,500 lbs (680 kg) winch kit complete with synthetic rope, roller fairlead, mounting plates and hardware. Specifically designed for the Renegade.

715000254

\$584.99



RT30 WARN WINCH KIT

Fully-sealed winch capable with 3,000 lbs (1,361 kg) of pulling strength. Includes a 0.9hp motor, 50' (15 m) of $\frac{3}{16}$ " (5 mm) wire rope, an ergonomically designed clutch knob, mechanical brake, hand-held remote and a potted-and-sealed mini-rocker handlebar switch, a waterproof contactor and a roller fairlead. CE certified.

715000528

\$524.99

XL2500 WINCH KIT FOR TRAXTER/QUEST

(Not illustrated)

Complete 2,500 lbs (1,134 kg) winch and mounting kit including a roller fairlead.

Traxter & Quest - 715000546

\$529.99

WINCH MOUNTING KIT

(Not illustrated)

All Traxter models - 715500108

All Outlander models - 703500547

\$34.99

NEW WINCH BRAKE KIT

(Not illustrated)

Upgrades standard winch with brake kit. Convenient for use with plow.

Fits all production Outlander with XL3000 winch

715001135

\$79.99





SYNTHETIC WINCH CABLE

Easier to manipulate than steel cable. Replaces the original cable on any factory installed Warn winch or sold as an accessory by BRP. Kit includes synthetic rope and rock guard sleeve. Always use with roller fairlead (715000011) to prevent premature wear.
50' (15 m) long. 3,000 lbs (1,361 kg) of strength. - 715000539
\$109.99
 For XT15 winch only. **40' (12 m) long. 1,500 lbs (680 kg) of strength.** - 715000593
\$99.99



WINCH ACCESSORIES KIT

Get the most out of your winch. Double your pulling power, change your pulling direction and keep your winch in proper working order. Includes tree straps, snatch block and shackle.
 715000005
\$134.99



WIRE ROPE REPLACEMENT

Play it safe. Always carry a replacement wire rope. 50' (15 m) aircraft grade steel wire. 3/16" (5 mm) diameter. 3,000 lbs (1,361 kg) of strength.
 All Warn winches - 715000047
\$44.99



WIRED REMOTE CONTROL

(Not illustrated)
 This kit allows the winch owners to add the hand-held remote to their winch. Works in conjunction with the mini-rocker switch.
 715000197
\$74.99

WIRELESS REMOTE CONTROL

The system is quick and easy to install, thanks to a wiring harness with an integrated antenna, and all necessary mounting hardware. The system allows you to operate your winch from anywhere within a 50' (15 m) radius, increasing your recovery options. All components are weatherproof. Works with all Outlander XT, Traxter/Quest XT MY 2004 and up and BRP accessory winches with a handlebar mounted mini-rocker switch.
 715000544
\$164.99



WINCH FAIRLEAD BRACKET

Allows for more winch cable clearance when using XT-style bumpers.
 Outlander XT, MAX XT - 715000696
\$39.99



HOOK WITH SAFETY LATCH & STRAP KIT

Heavy-duty winch-rope hook with stainless steel snap. Includes a nylon safety strap.
 715000069
\$16.99



ROLLER FAIRLEAD

Features top, bottom and side rollers for less cable wear and smoother operation from any direction for easier winching.
 715000011 Black
\$44.99



RENEGADE TRAILERING COVER

300-denier solution-dyed, water-repellent polyester construction. Fits with or without mirrors and windshield attachment brackets (windshield must be removed). Key wear areas are reinforced.

280000316
\$149.99



DS 450 TRAILERING COVER

X-attachment system. 300-denier solution-dyed, water-repellent nylon. Key areas are reinforced. Includes sponsor graphics.

280000346
\$149.99

OUTLANDER TRAILERING COVER

(Not illustrated)
 X-attachment system. 300-denier solution-dyed, water-repellent polyester construction. Fits with or without mirrors and windshield. Key areas are reinforced.

Outlander with Trunk Box - 715000675
\$179.99

Outlander - 715000682
\$149.99

Outlander MAX - 715000681
\$159.99



STORAGE COVER

For storage use only. Fits with or without windshield and mirrors. Heavy-duty elastic cord around bottom for secure fit.

100-denier polyester construction
 Outlander MAX - 715000676 Black
\$109.99

Outlander - 715000677 Black
\$99.99

Vinyl construction
 Renegade - 715000678 Black
\$99.99

DS 450 - 280000347 Black
\$99.99

DS 250 - 715000261 Black
\$84.99



PREMIUM MODULAR BAG

Multi-configuration four section bag. Constructed of 600-denier, solution-dyed, water-repellent polyester. Semi-rigid thermoformed structure. Heavy-duty water-resistant zipper. Easily converts into a duffle bag.

Outlander 2006-2011 - 280000296 Black
\$179.99



FRONT BAG

100% water-repellent polyester construction. Designed to fit with or without a rack extension. Integrated map holder. Waterproof zippers.

Outlander 2006-2011 - 715000235 Black
\$119.99

Outlander 2004-2005 - 295100276 Black
\$114.99



REAR BAG

100% water-repellent polyester construction. Designed to fit with or without a rack extension. Waterproof zippers.

Outlander 2006-2011 - 715000234 Black
\$119.99

Outlander 2004-2005 - 295100277 Black
\$114.99

DS 250 - 715000264 Black
\$89.99



REAR BAG

Constructed of 600-denier, solution-dyed, water-repellent polyester. Semi-rigid thermoformed structure. Quickly and easily converts into a practical backpack. Heavy-duty water-resistant zipper. Easy to install and remove.

Renegade - 280000295 Black
\$89.99



GPS MOUNT

Find your way home. Great for the ATV riding environment. This mount holds steady any GPS under high vibration conditions.

715000120 **Black**
\$89.99



CELL PHONE MOUNT

Keep your phone close by when working or riding. The unique design of this mounting system offers easy installation, mobility, strength and versatility.

715000122 **Black**
\$89.99



HOOK HOLDER

An easy way to carry your tools, firearm or bow over any terrain with confidence. Swivels to allow various mounting positions for multiple applications. Allen wrench is included for easy installation to your tubular rack.

Single - 715000042 **Black** **Double** - 715000043 **Black**
\$49.99 **\$69.99**



HAND HELD LIGHT

High-intensity rubber spotlight comes standard with a one-inch diameter double ball and socket system. Designed to withstand more than 50 g of shock. Can be easily moved from your handlebar, rack or any other location you choose. Plugs into 12V DC outlet.

715000007 **Black**
\$79.99



CUP HOLDER

Mounts easily to handlebars or racks.

715000121
\$73.49



BRP CAN-AM VANITY PLATE

484800455
\$12.99



TIE-DOWN

Our 100% polyester ratchet-style tie-down measures 10' (3 m) in length and ensures a safe load with its unique soft loop strap design.

715000276 **Black**
\$14.99

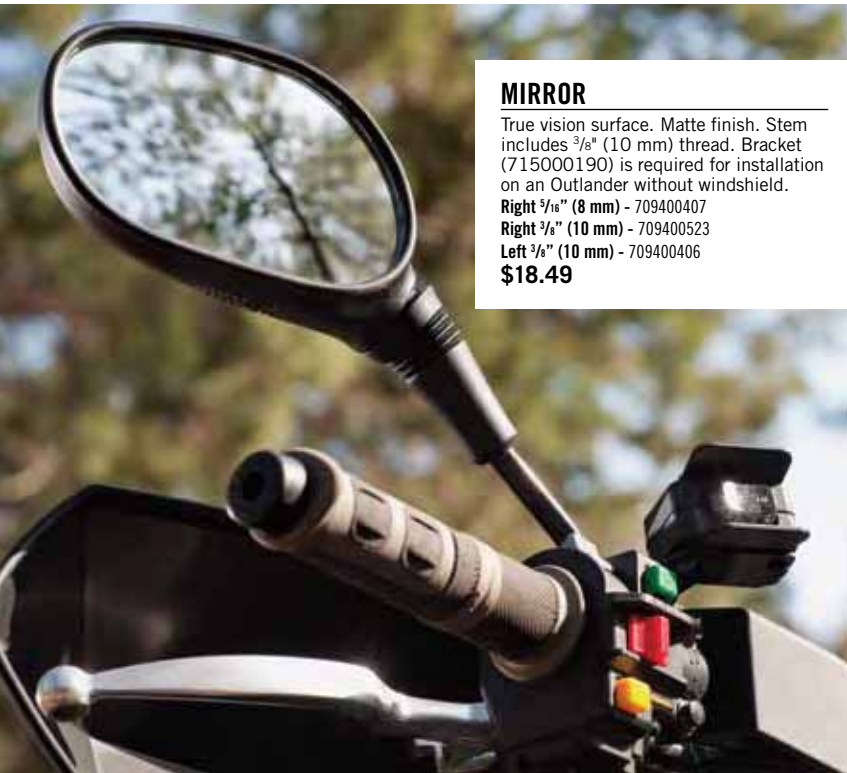

MIRROR

True vision surface. Matte finish. Stem includes 3/8" (10 mm) thread. Bracket (715000190) is required for installation on an Outlander without windshield.

Right 3/16" (8 mm) - 709400407
Right 3/8" (10 mm) - 709400523
Left 3/8" (10 mm) - 709400406
\$18.49

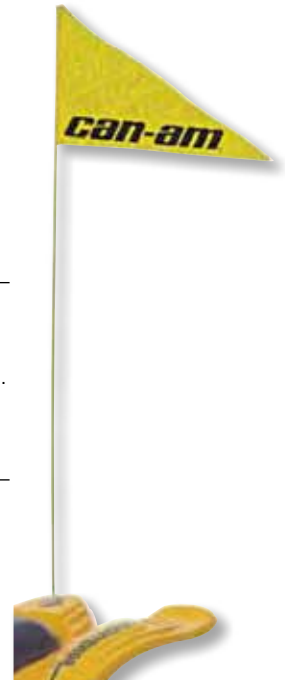

FLAG

Make sure everyone knows what you're riding. Perfect for the dunes and new riders. 8-foot (2.4 m) length. Includes flag mount (715000127).

715000277 **Yellow**
\$19.99

FLAG MOUNT

715000127
\$19.99

PRIME TLC FOR YOUR ATV

Original Equipment Manufacturer and Manufacturer Recommended Products & Kits

You own a Can-Am ATV because you demand the very best from your machine. Take care of your ATV by maintaining it using strictly BRP and Rotax OEM or 100% Can-Am approved parts and products, and enjoy levels of performance that make every Can-Am ATV ride or functional application a uniquely original experience.



XPS 4-STROKE OIL CHANGE KIT

Complete maintenance right out of the box: O-Ring, XPS oil, Rotax oil filter and instruction sheet.

Summer use - 703500736

All climate use - 703500735



CARLISLE† TIRES

The complete collection of Carlisle tires for Can-Am ATVs under one roof.

Front - 705400431

Rear - 705500606

\$96.99

\$93.49



BRAKE PAD KIT

One-stop replacement brake pad kit designed to replace the parts while keeping your ATV's performance intact.

705600349

705600350

\$39.99



UNI FOAM OIL FILTER

Allows maximum airflow while keeping the dirt and dust particles out.

5½ oz. 219700340

\$73.99



UNI FOAM FILTER CLEANER

Uni Filter Cleaner's powerful agents quickly strip away grease and dirt, yet won't damage air filters.

14½ oz. 219700341

\$101.99

YUASA† BATTERIES

Top of the line models from the leading preferred original equipment battery supplier in the U.S.

18 Amps. Wet (YTX20L-BS)

410301203

\$114.49

19 Amps. Dry (YB16CL-B)

278001756

\$76.99

13 Amps. Wet (YTX15L-BS)

710000283

\$121.99

Dry (YB30CLB)

278001882

\$133.49

3 Amps. Wet (YT4L-BS)

410301204

\$53.99

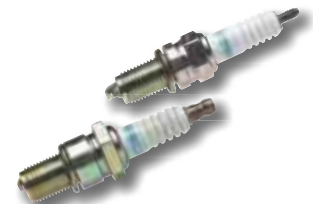

NGK† SPARK PLUGS

BRP dealers carry the full line of premium NGK spark plugs for Can-Am ATVs.

707000246

\$3.50

BECAUSE ONCE YOU RIDE WITH THE BEST, ANYTHING LESS IS MIDDLE OF THE ROAD.

See your Can-Am ATV Authorized Dealer for the full line of OEM and manufacturer recommended parts and products.

MAINTENANCE





XPS DOT 4 BRAKE FLUID

Exceeds DOT 3 and 4 requirements. Unique low-moisture formulation providing maximum protection against vapor lock. Recommended in Ski-Doo snowmobiles and Can-Am off-road vehicles.

293600131
\$4.99



XPS 4-STROKE OIL CHANGE KIT

Kit includes: 3 quarts of XPS synthetic blend oil, oil filter, o-ring and instruction sheet.

For Renegade, Outlander & Commander
 Summer use - 703500736 All climate - 703500735



XP-S SYNTHETIC SUSPENSION GREASE

Specially designed for Can-Am off-road vehicle suspensions. Offers optimal lubrication at low and high temperature extremes while protecting critical suspension components from dirt and other contaminants.

400 g - 293550033
\$94.99



FUEL STABILIZER

Fuel additive to protect against fuel contamination and residue build-up in carburetors and gas lines. Should always be used before storing your Can-Am off-road vehicle. Suitable for all gasoline engines.

413408601
\$8.49



XPS 4-STROKE SYNTHETIC OIL - ALL CLIMATE GRADE

Unlike other ordinary 4-stroke motor oils, XPS all climate grade synthetic 4-stroke oil is specifically engineered to meet the particular lubrication requirements of the Can-Am off-road vehicles equipped with Rotax 4-TEC™ 4-stroke engines. Provides easier starting in very cold temperatures.

1 quart / 946 ml - 293600112 1 US gallon / 3.785 L - 293600115



XPS 4-STROKE BLEND OIL - SUMMER GRADE

Synthetic blend 4-stroke engine oil for the Rotax 4-TEC engine. XPS summer grade synthetic blend off-road vehicle engine oil is a high performance oil developed for riders that demand maximum engine performance and protection during all operating conditions.

1 quart / 946 ml - 293600121
 1 US gallon / 3.785 L - 293600122



PRE-MIXED ANTIFREEZE/COOLANT

Pre-mixed ready to top up your coolant level. Blended to perform best in our Rotax engines with anti-corrosive additive.

219700362
\$7.49



FLEXIBLE SPOUT

To use your 1 quart / 946 ml, 1 US gallon / 3.785 L oil bottles for spill-free pouring. Easy installation.

414837300
\$6.49

XP-S LUBE

A multipurpose lubricant that prevents rust, corrosion and moisture intrusion. Contains active extreme-pressure additives which provide excellent lubricity and antiwear properties. Comes in a spray can that works upside down.

14 oz. - 293600016
\$9.99

XP-S STORAGE OIL

This specialty oil is a must when putting your Can-Am off-road vehicle away for extended periods. Specially formulated to protect the engine's internal parts from the hazards of rust and corrosion due to condensation during storage or prolonged periods of non-use.

350 g - 413711900
\$8.99

XPS OFF-ROAD VEHICLE HPG-T/A GAS SHOCK OIL

Recommended for all top quality gas shocks for off-road vehicle including our own Can-Am HPG-T/A nitrogen gas charged shocks. High viscosity index for extreme temperatures encountered in off-road vehicle conditions.

293600136
\$65.99

Note: Please contact your nearest dealer for suggested retail prices of oil based products.

XPS CLEANING PRODUCTS



XPS MICROFIBER TOWELS

The latest in high-quality detailing towels. Made up of extremely fine fibres, their soft surfaces have been perfected for drying and polishing motorcycles, boats, cars or any shiny finish. They are so absorbent they hold up to seven times their weight in water. Machine washable means they can be used over and over again.

Packs of 2 219701759
\$8.49



XPS OFF-ROAD VEHICLE WASH

A biodegradable and non-toxic cleaner that removes mud and dried-on dirt from your off-road vehicle. Whether grimy from the track, the woods or the fields, this cleaner will leave your off-road vehicle sparkling. When used as directed, XPS ATV Wash is safe for all off-road vehicle finishes.

32 oz. / 946 ml 219701702
\$9.99



XPS FINISHING SPRAY

The final touch to your detailing job. Uses an advanced silicone product. Melon-scented spray quickly treats faded plastics, vinyl, rubber and more to restore their original look. Long lasting, it helps keep mud and dirt from sticking to your vehicle's finish and does not leave streaks or spots. Contains no ozone depleters and no chlorinated solvents.

12 oz. / 340 g 219701704
\$8.49



XPS BRAKES & PARTS CLEANER

A concentrated blend of solvents with a powerful blasting spray that effectively removes grease, grime, brake fluid and other contaminants from brake components and metal parts without the need for disassembly. Evaporates instantly and completely leaving no residue to hinder performance. Contains no ozone depleters.

14 oz. / 397 g 219701705
\$7.99



XPS OFF-ROAD VEHICLE CLEANING KIT

Kit includes: XPS off-road vehicle Wash, XPS Finishing Spray and XPS Microfiber Towels.

219701713
\$24.99

DECALS



6" x 12 3/4" (15 cm x 32 cm)
 704901484
\$11.99



6" x 12 3/4" (15 cm x 32 cm)
 704901483
\$11.99



12" x 4" (30 cm x 10 cm)
 704901482
\$11.99



Set of 2. 2" x 6" (5 cm x 15 cm)
 704901480
\$9.99

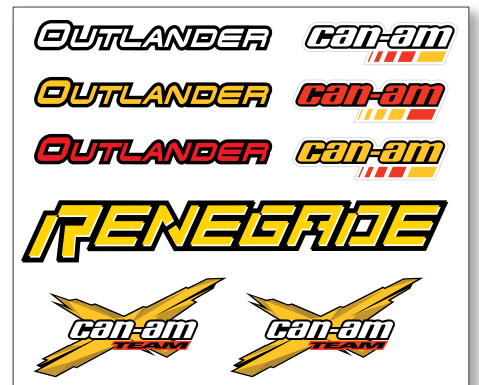

9 per sheet. 24" x 8" (60 cm x 20 cm)
 704901481
\$10.99